

# Outdoor LED Foldable Screen

Smart plus Smart T plus Magic plus

The Onumen line of innovative products take only 2 people, 1 hour, to install 100 square meters of high quality video screens.





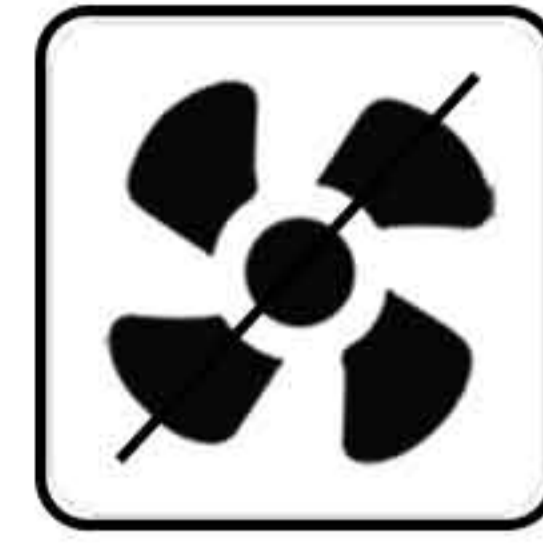
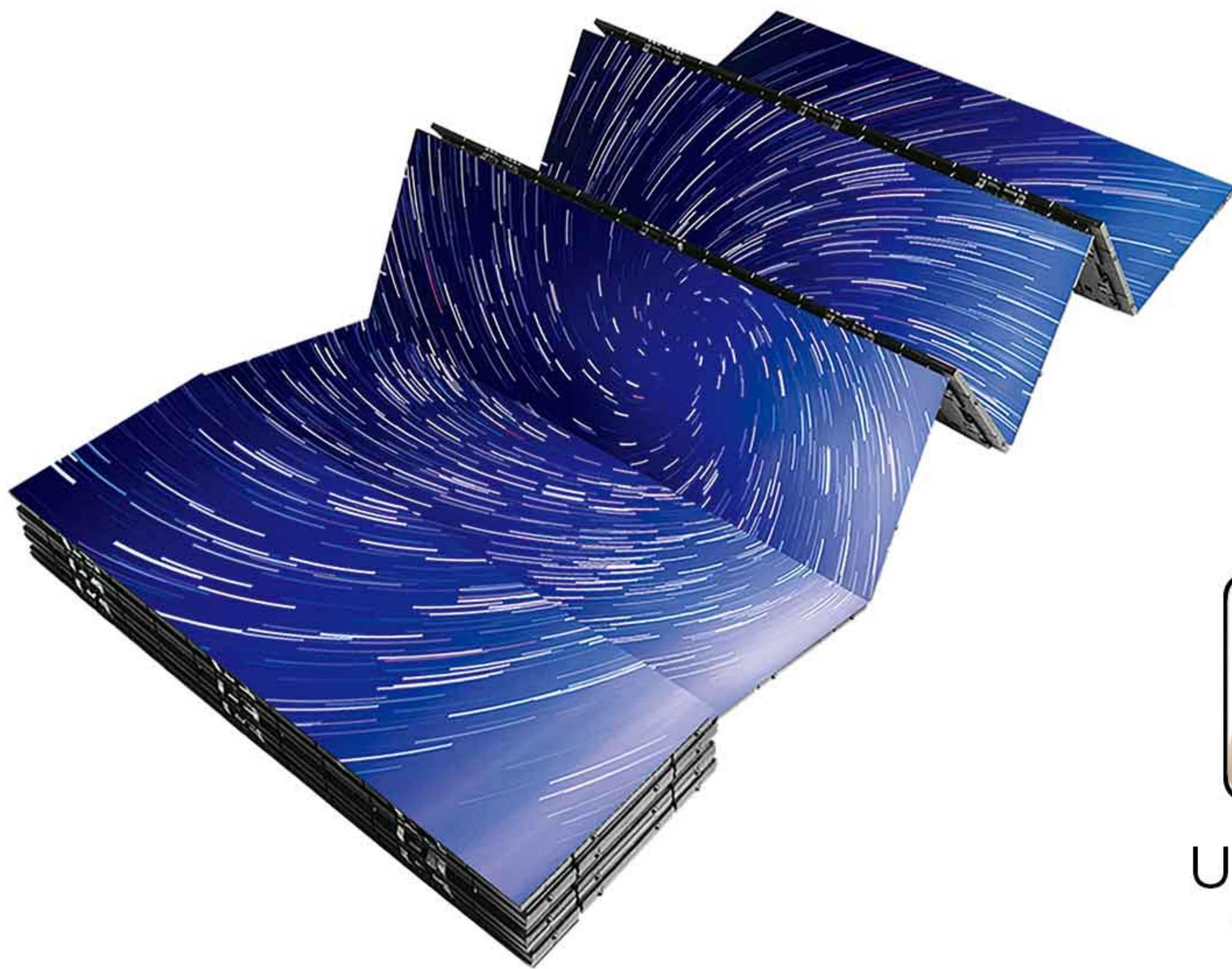

No fan

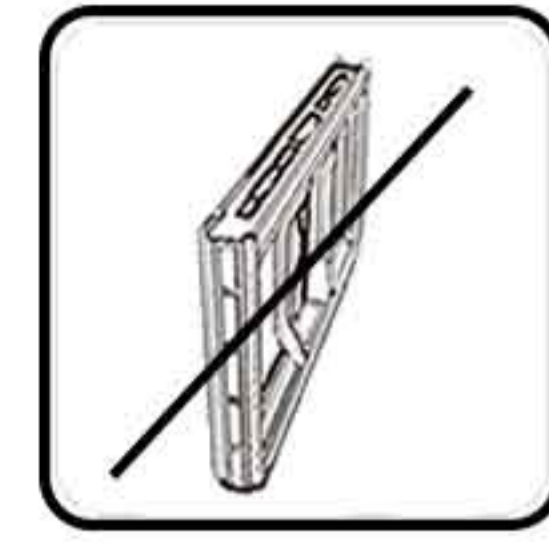

No frame



Ultra-thin  
15 mm



Ultra-light  
12kg/m<sup>2</sup>



360°  
foldable

1 Power supply and screen body separate design

2 Dual soldering and plug-in connectors design

3 Double fixing of magnet and screw

4 Screen load bearing

5 Standardized installation structure

6 Front and back maintenance

7 High protection level

8 High reliability



## Power supply and screen body separate design

External power supply, no need fan or air conditioner to dissipate heat;  
 Low temperature operation, long service life;  
 Low failure and high reliability.

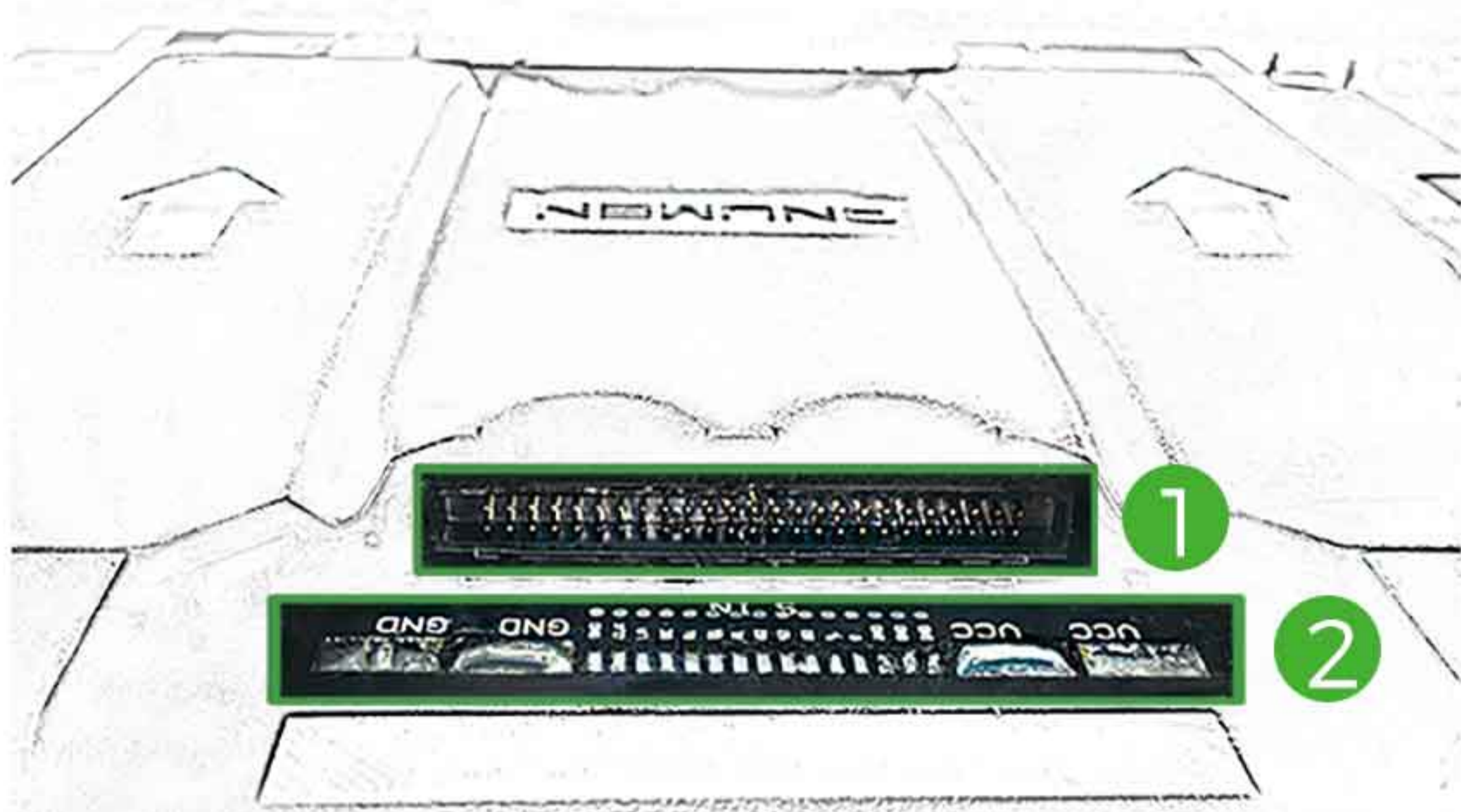
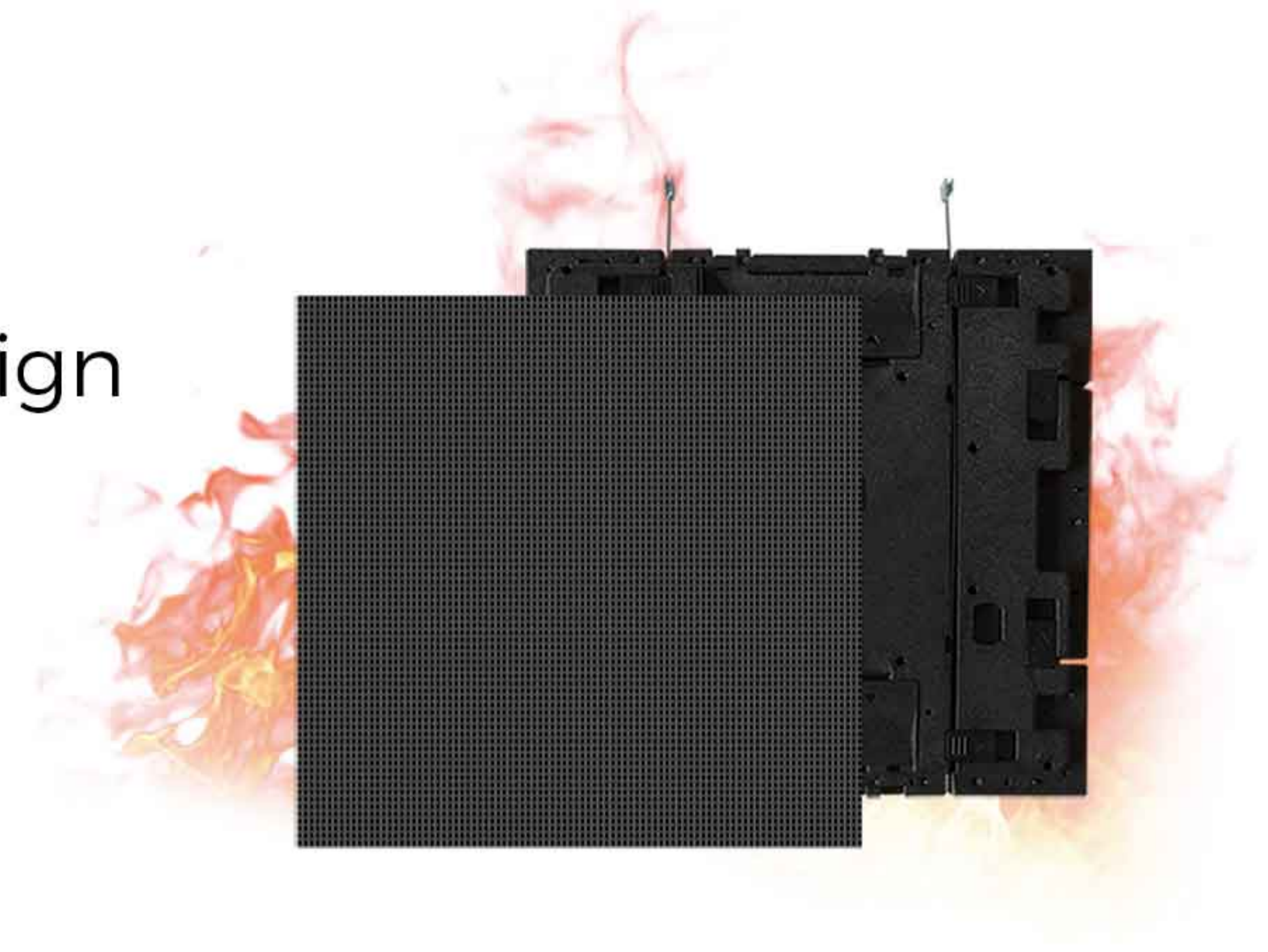

- ① Plug-in PIN connector(Backup)
- ② Soldering PIN connector(Standard)

## Double fixing of magnet and screw

The screen body can be fixed on the mounting frame through the built-in magnets,  
 The screen body can also be fixed on the mounting bracket through the unit board with stainless steel screws.

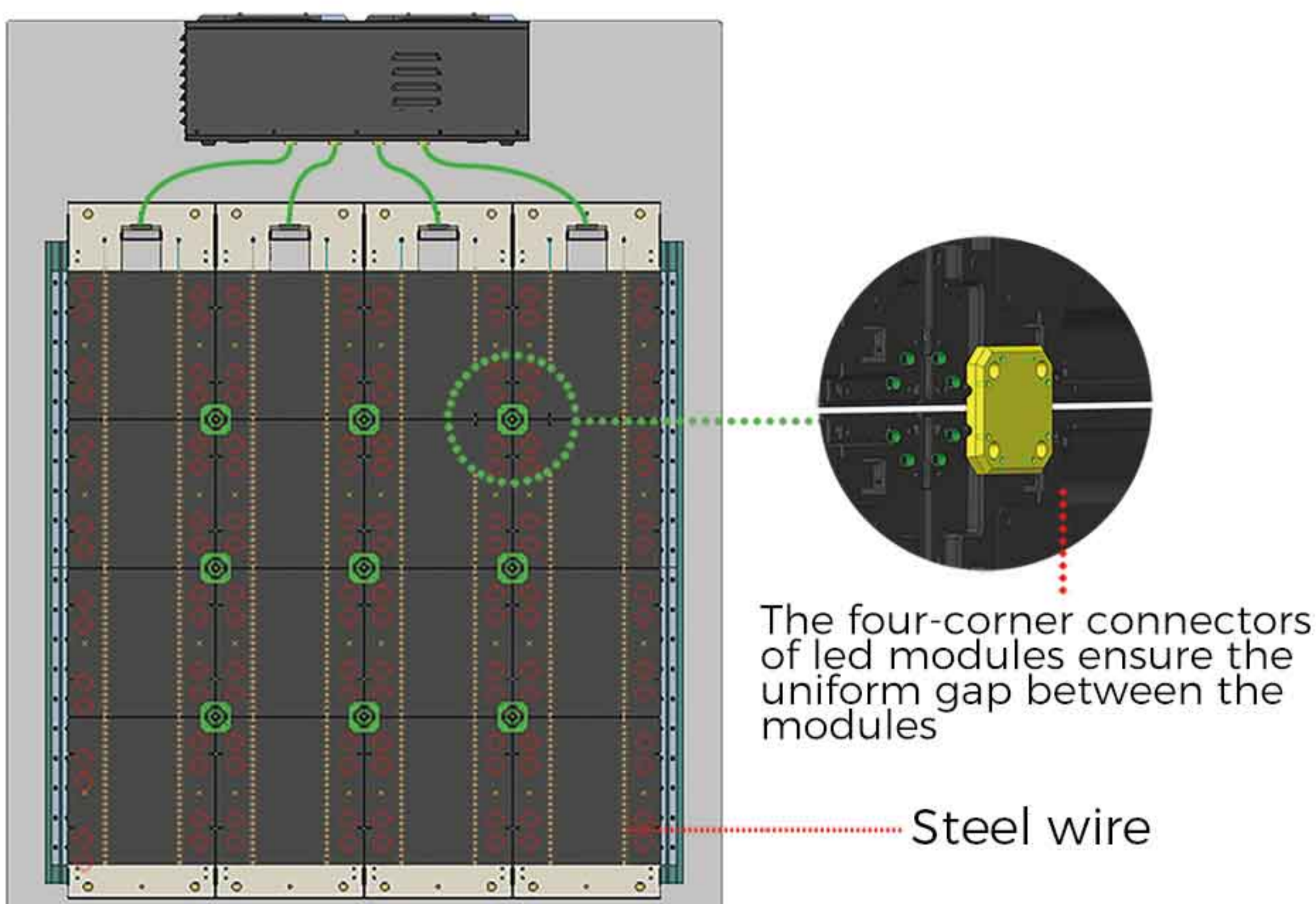
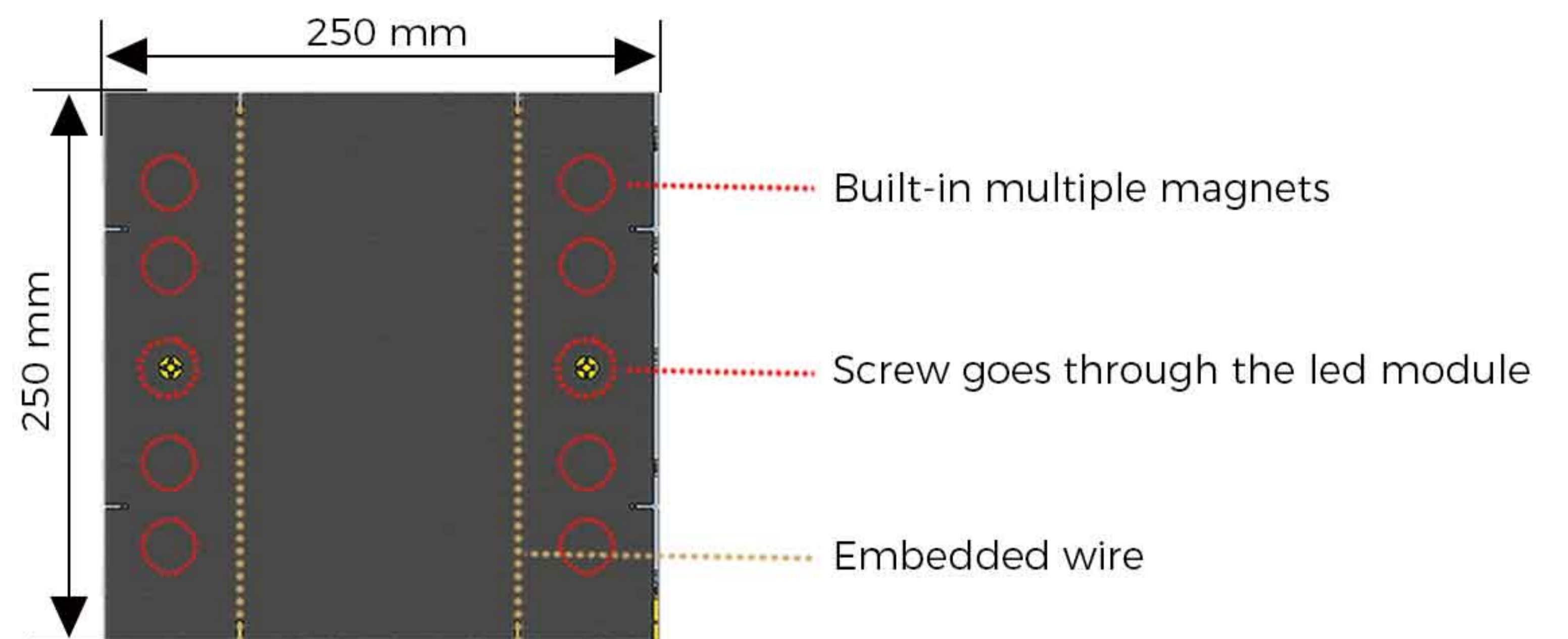

## Screen load bearing

Each 0.25m wide unit board has 2 built in steel wires  
 Maximum bearing capacity 750KG = 50 m<sup>2</sup>,  
 maximum 250m height .

The head and tail of the steel wire are fixed on the head and tail of bearing beam with bolts.  
 The bearing beam is fixed to the mounting bracket with bolts.





## Standardized installation structure

The screen is light, only 12 kg/m<sup>2</sup>, and thin, thickness is only 15 mm, minimize installation structure and minimize impact on buildings. Easy and quick to install, training is simple. Outdoor displays can be installed in batches.

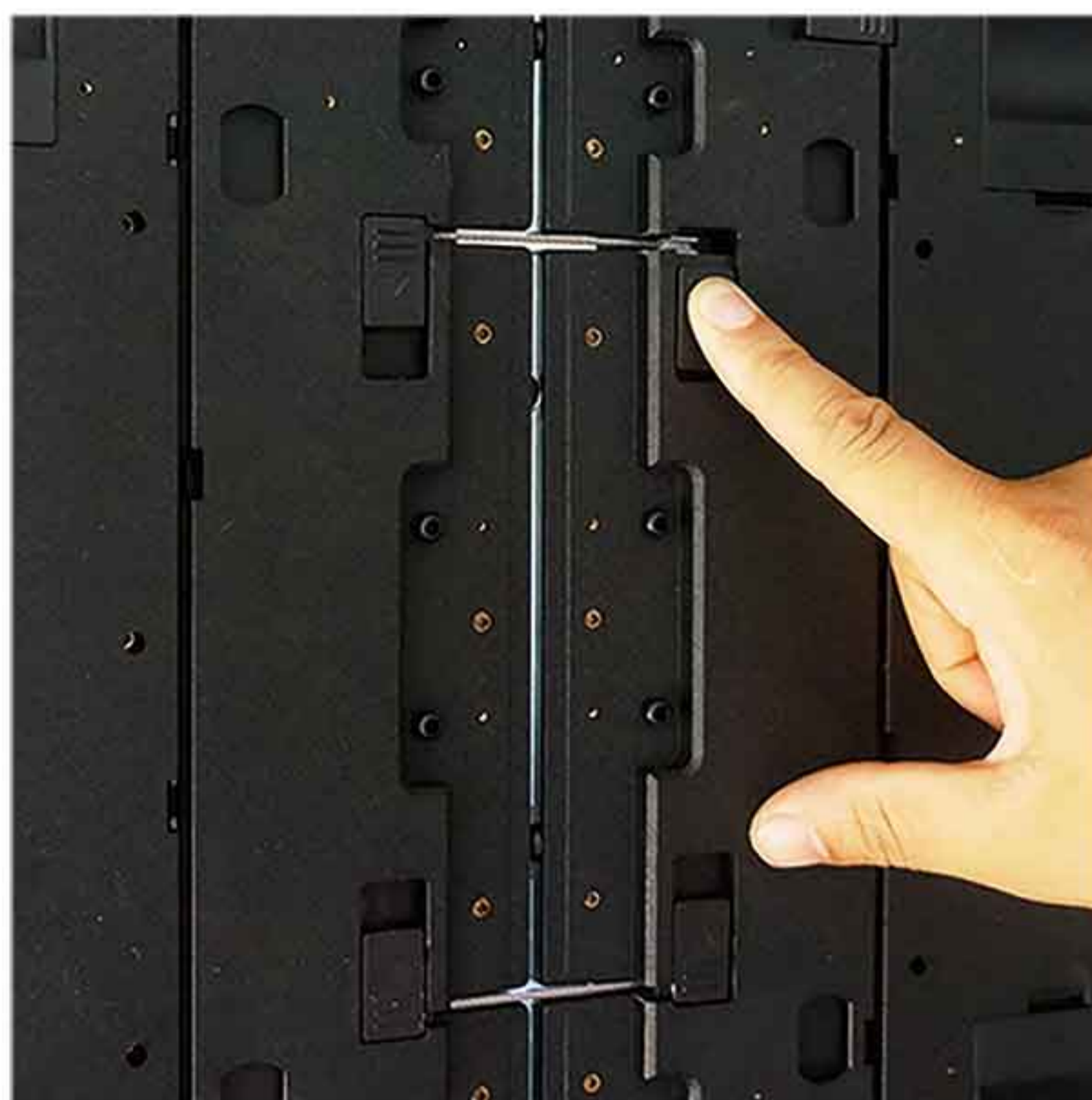
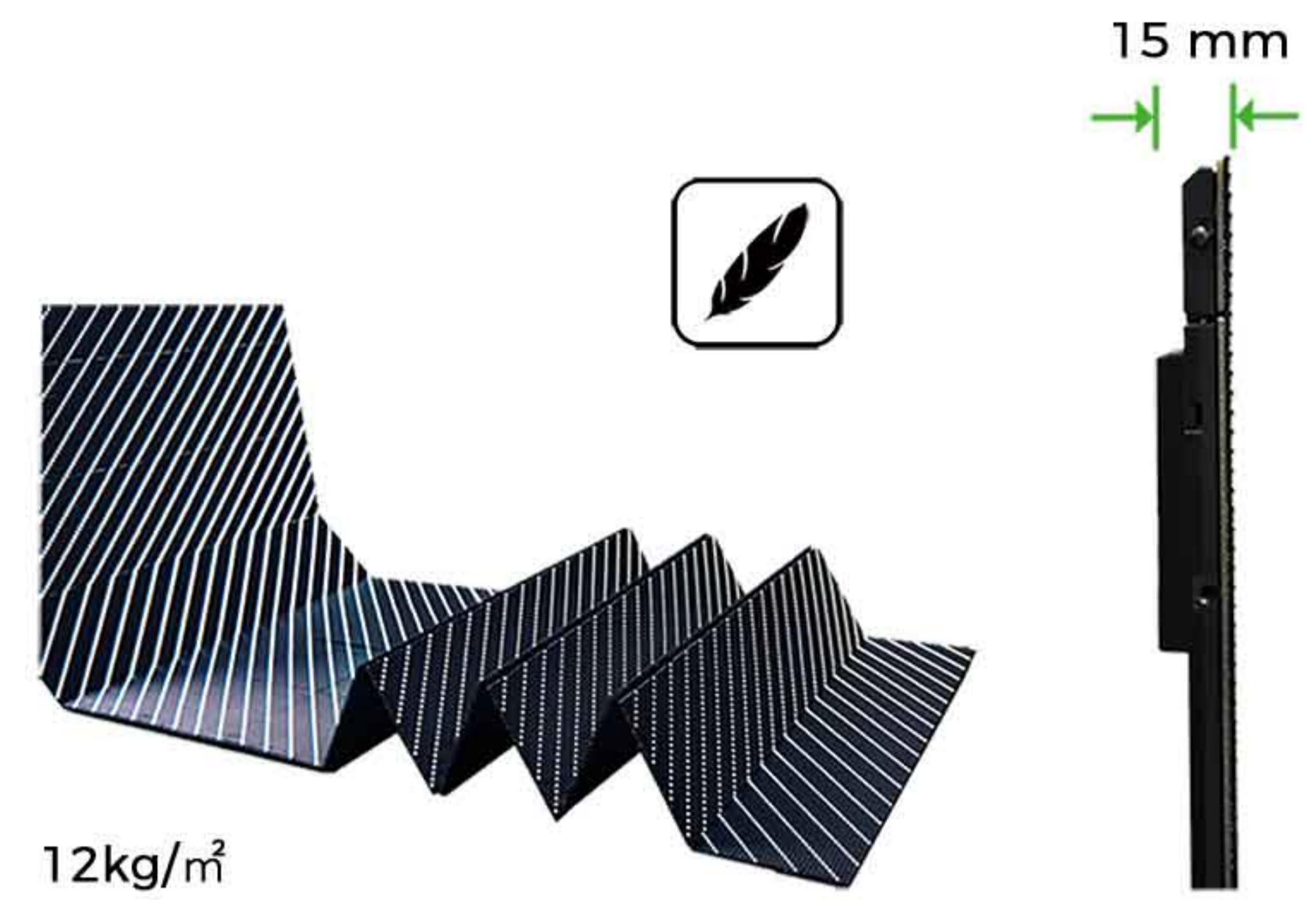

## Front and back maintenance

Support front or back maintenance, depending on how it is installed; Support to replace unit board.

## High protection level

Glue filling on double-sided unit board to be completely waterproof, IP65. 100% immersion aging test before shipment.

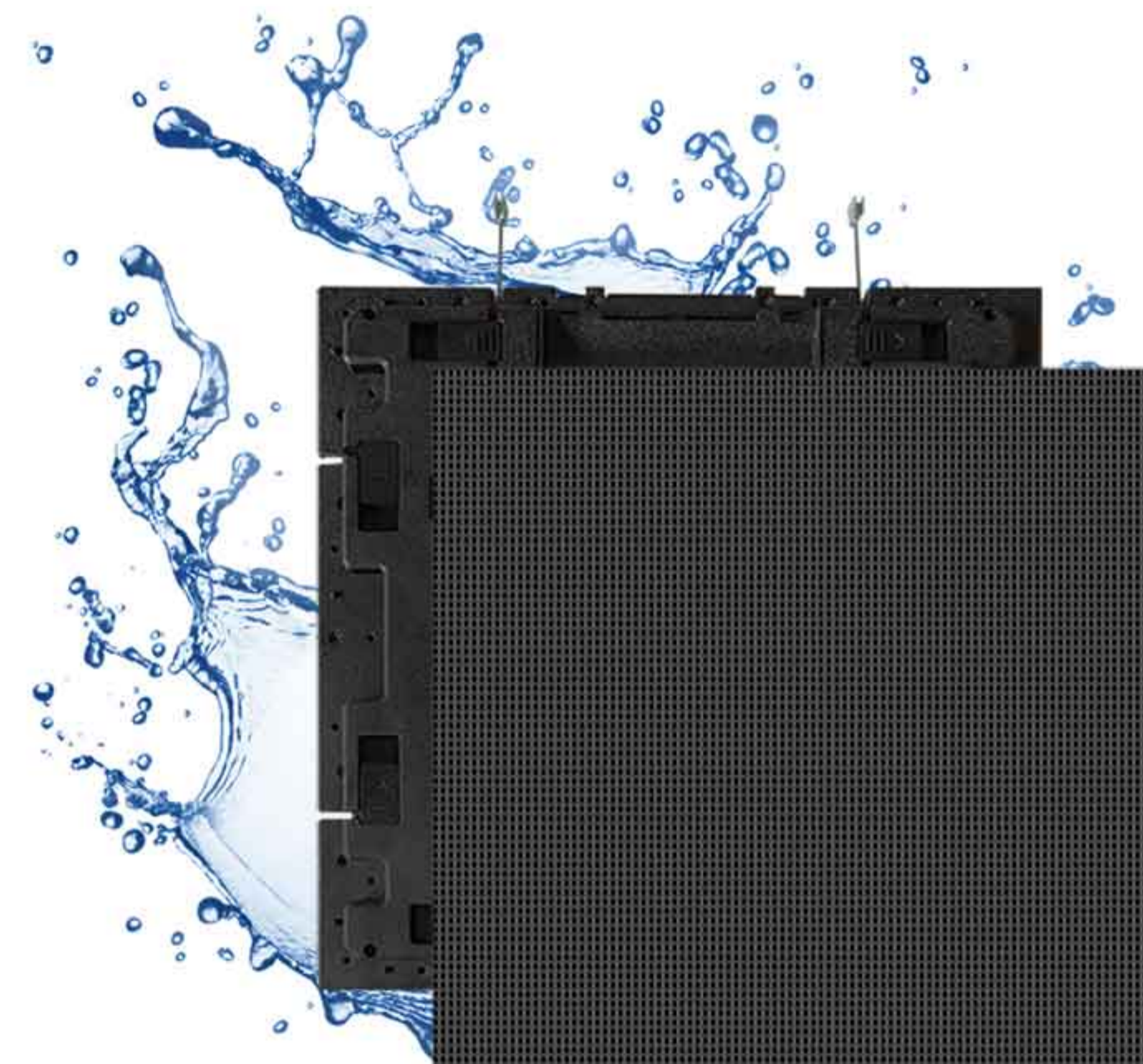

## High reliability

No connectors and low heating are to ensure the screen is stable. Reliable work, basically no maintenance in 2-3 years, extended warranty for up to five years (except led lamp)





# Product features



Ultra-slim  
23.5 mm



Lightweight  
15kg/m<sup>2</sup>



Foldable  
360°



"Hollow out"  
Design



No fan

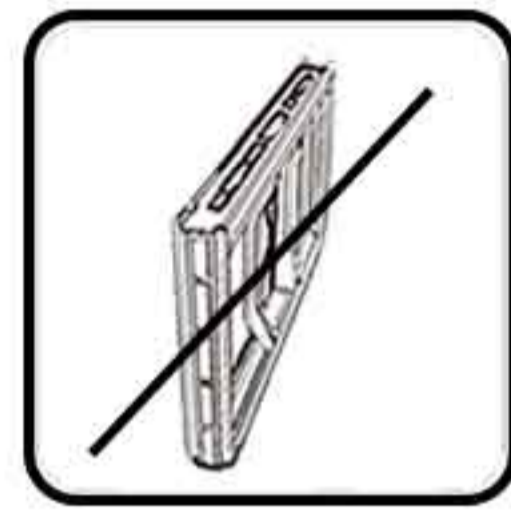

No frame

- 1 Power supply and screen body separate design
- 2 Low temperature operation
- 3 Dual soldering and plug-in connectors design
- 4 High bearing capacity
- 5 Standardized installation structure
- 6 Front and back maintenance
- 7 High protection level
- 8 High reliability

7.8

## Module size

15.6

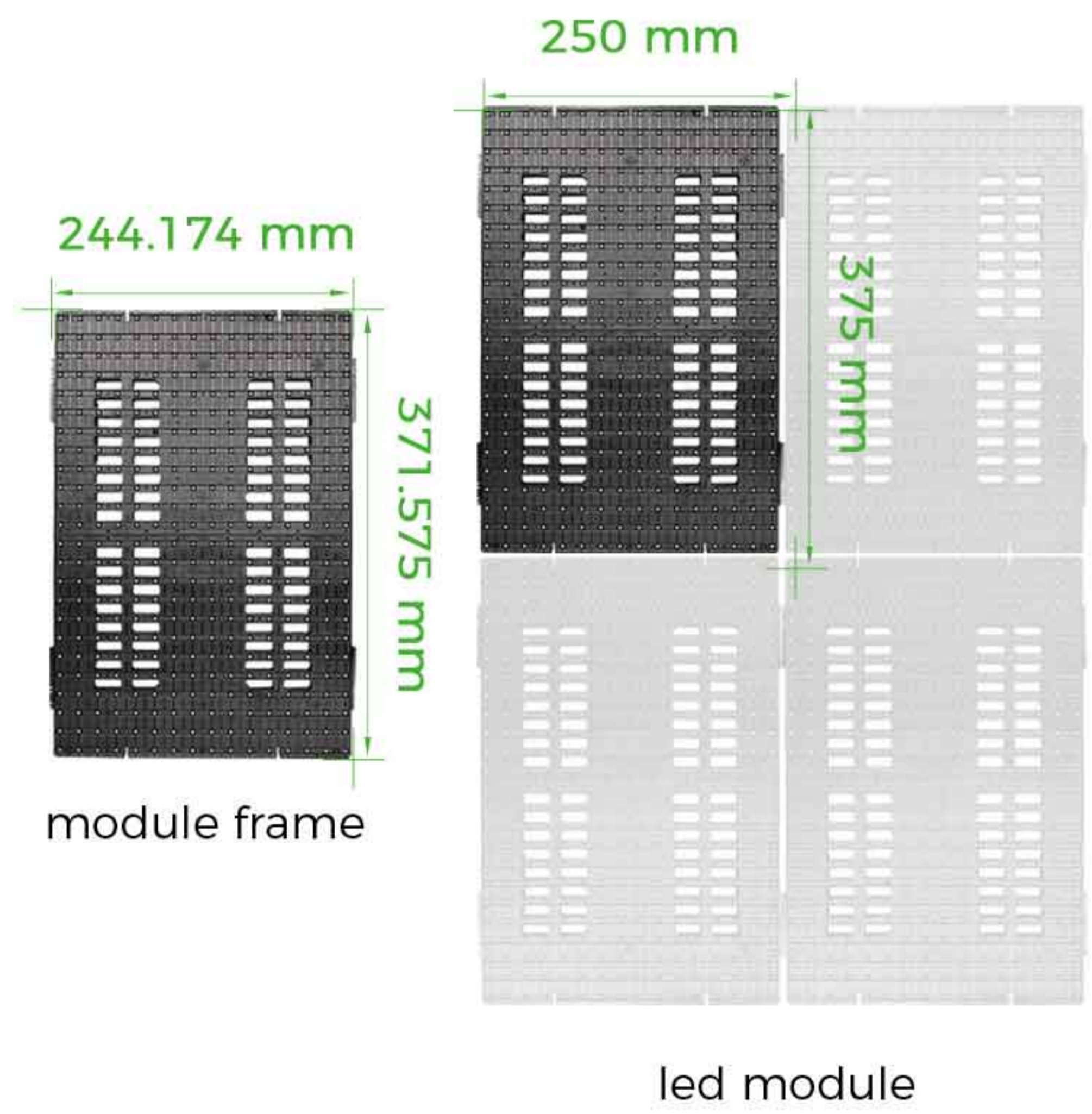
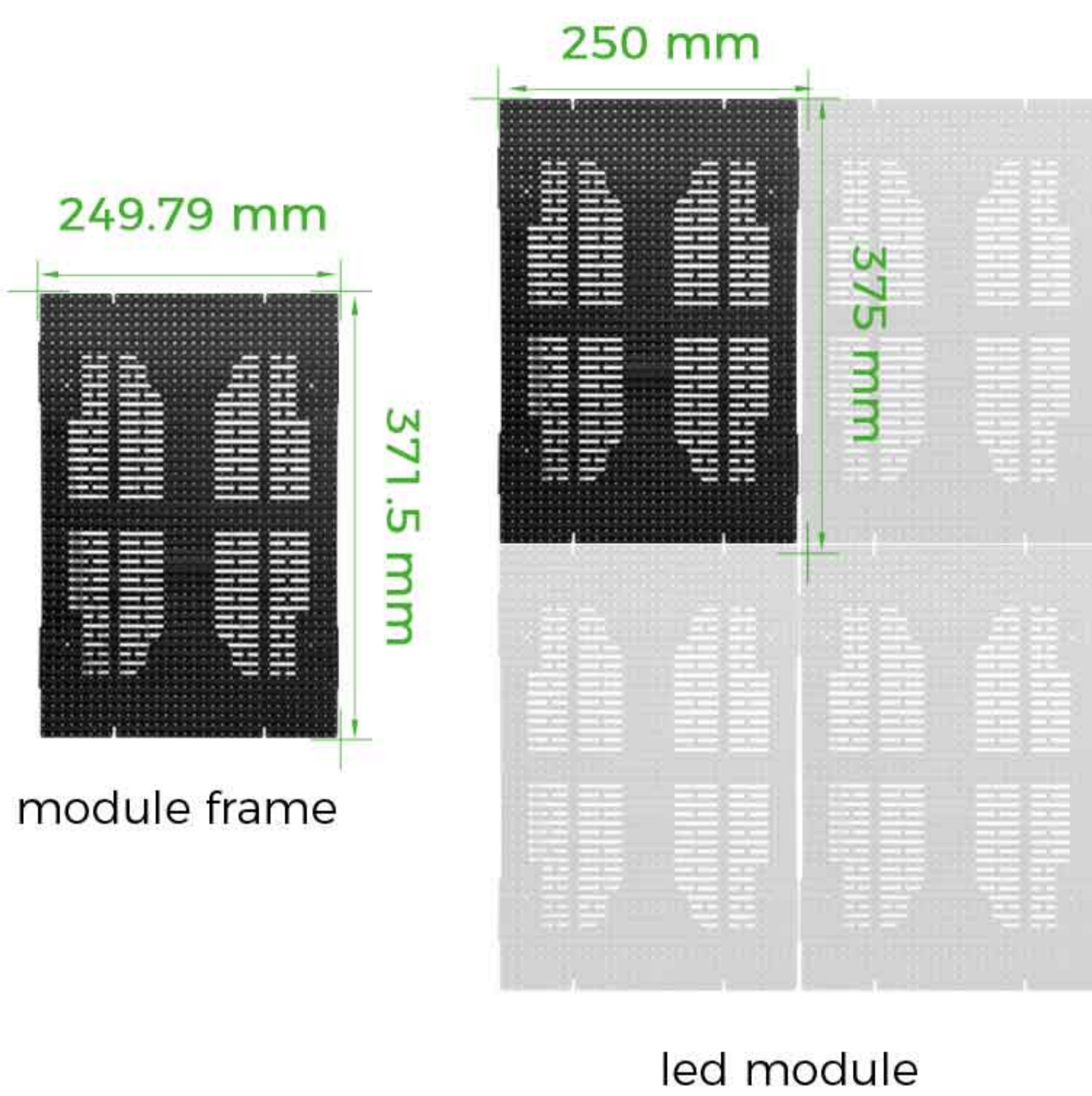

37.5

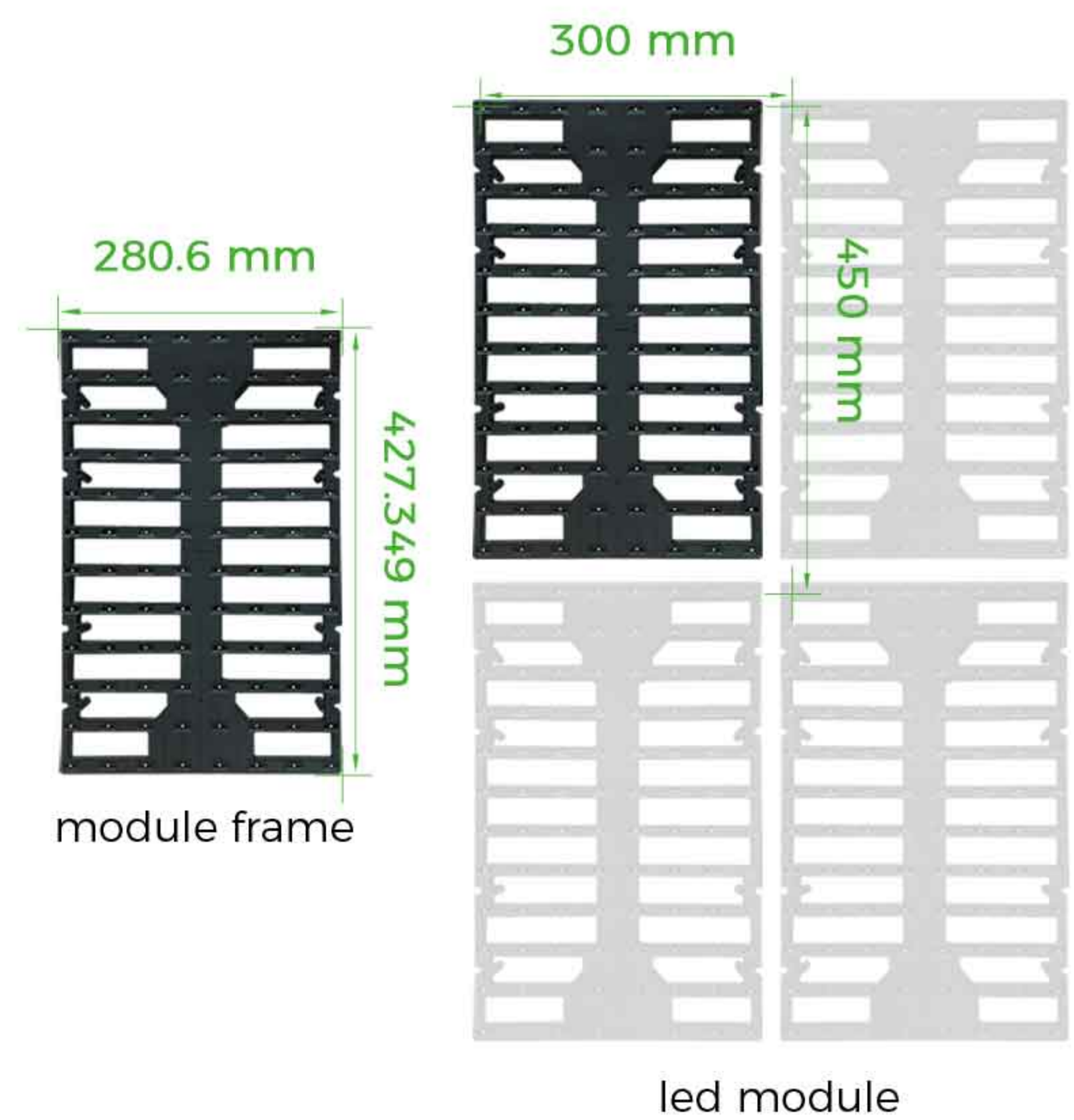



► **Power supply and screen body separate design**

External power supply, no need fan or air conditioner

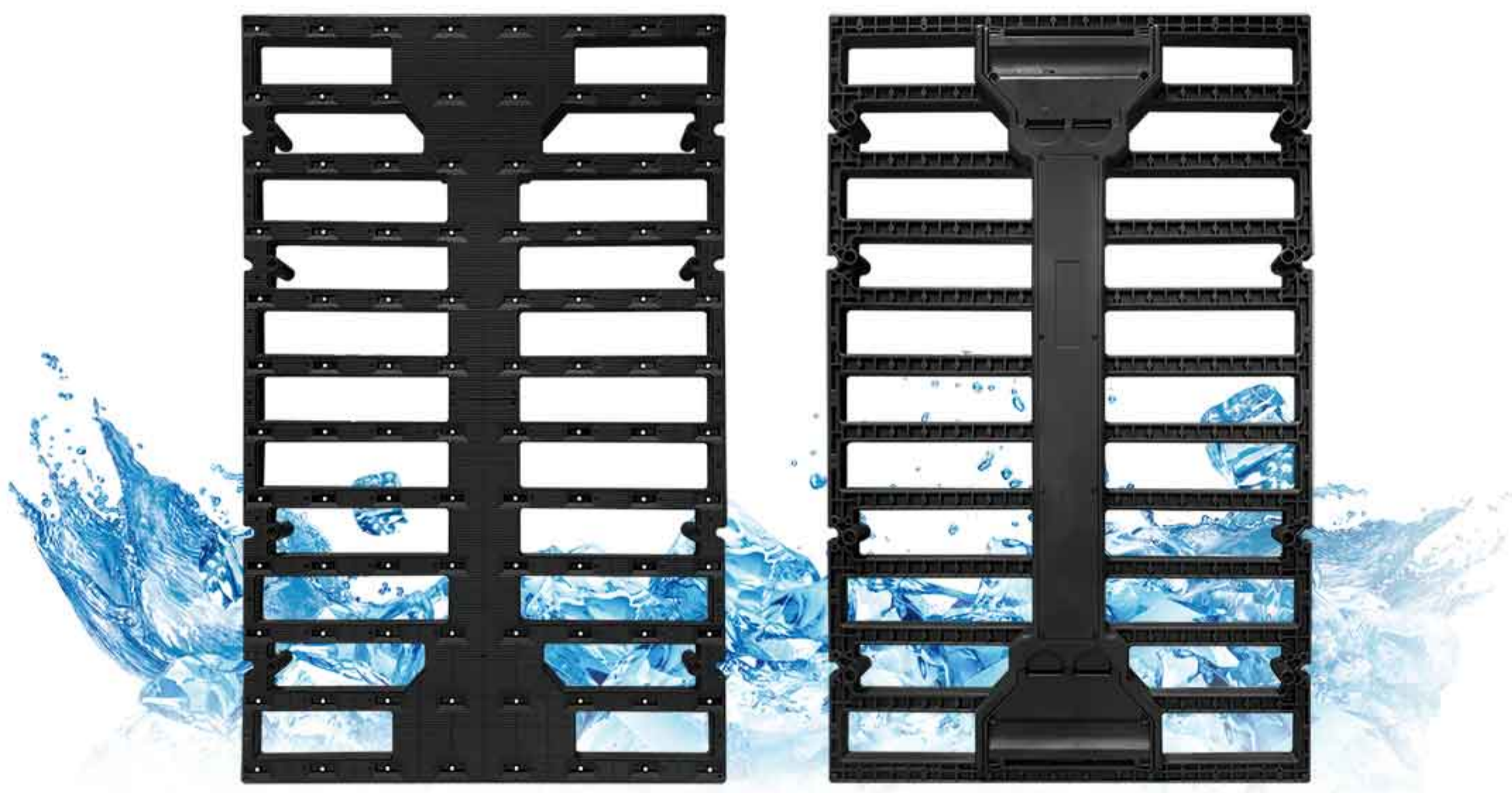
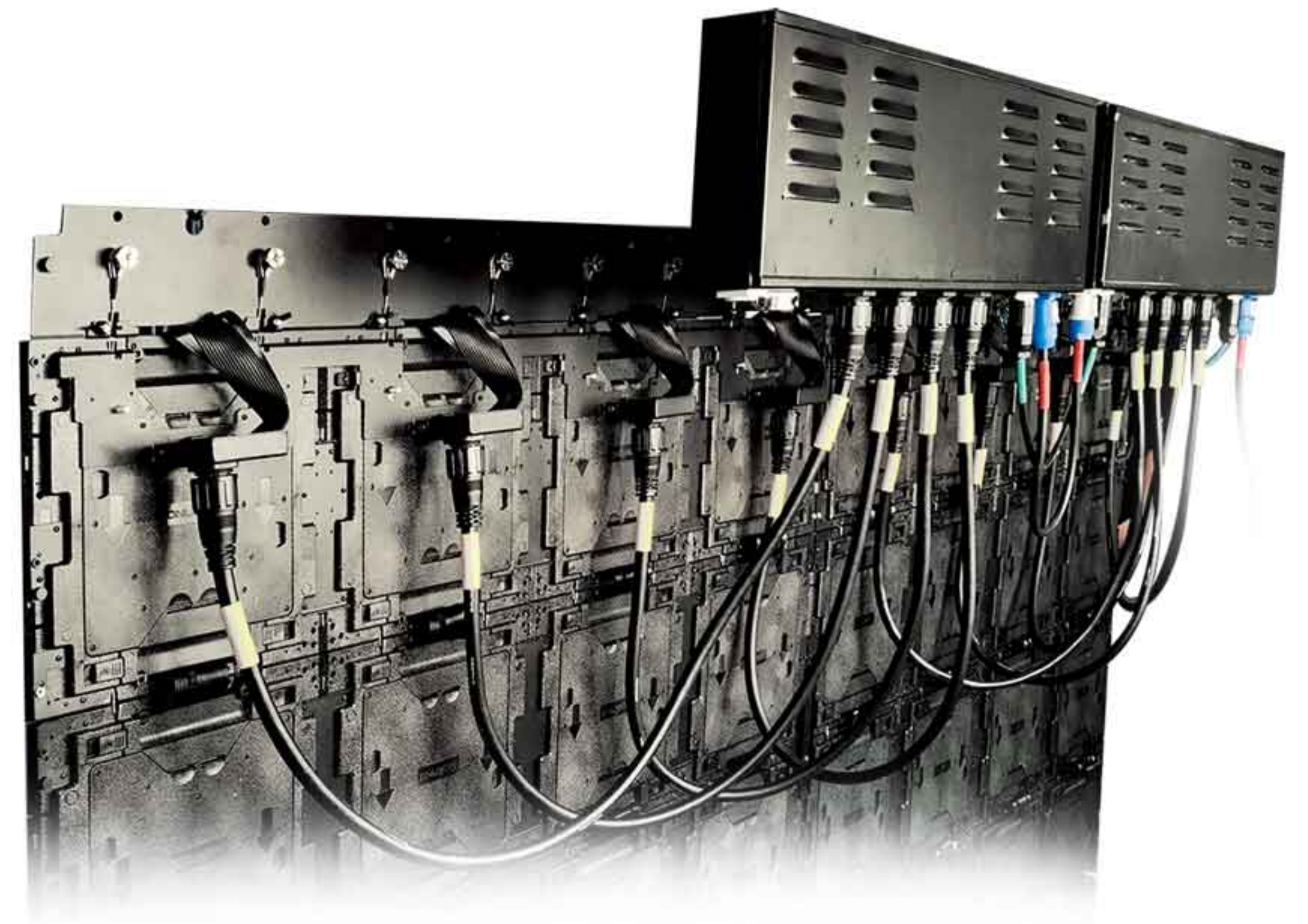

◀ **Low temperature operation**

Low temperature operation, long service life;  
Low failure and high reliability.

► **Special soldering and plug-in dual connectors design**

Soldering PIN connector is for stable performance,  
backup plug-in PIN connector is for quick replacement

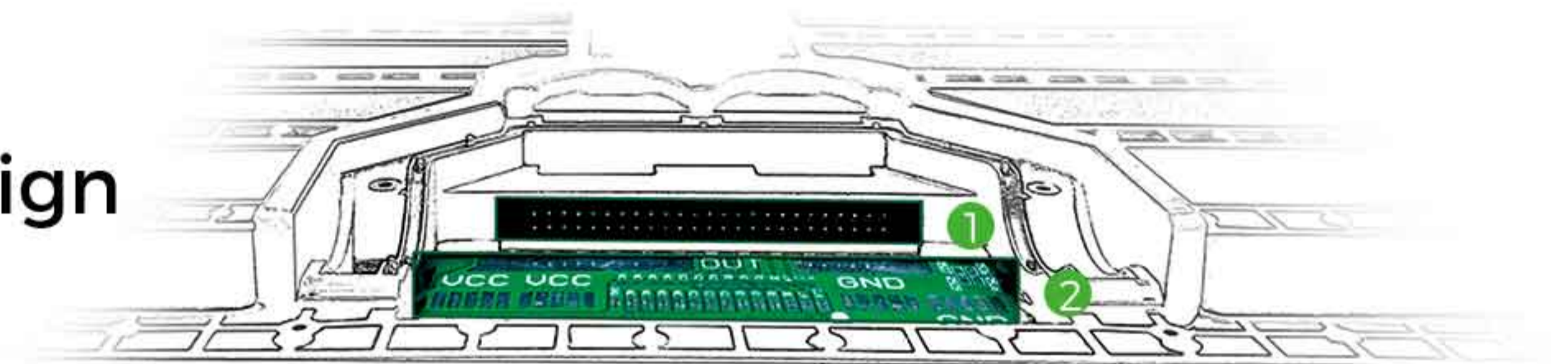

- ① Plug-in PIN connector(Backup)
- ② Soldering PIN connector(Standard)

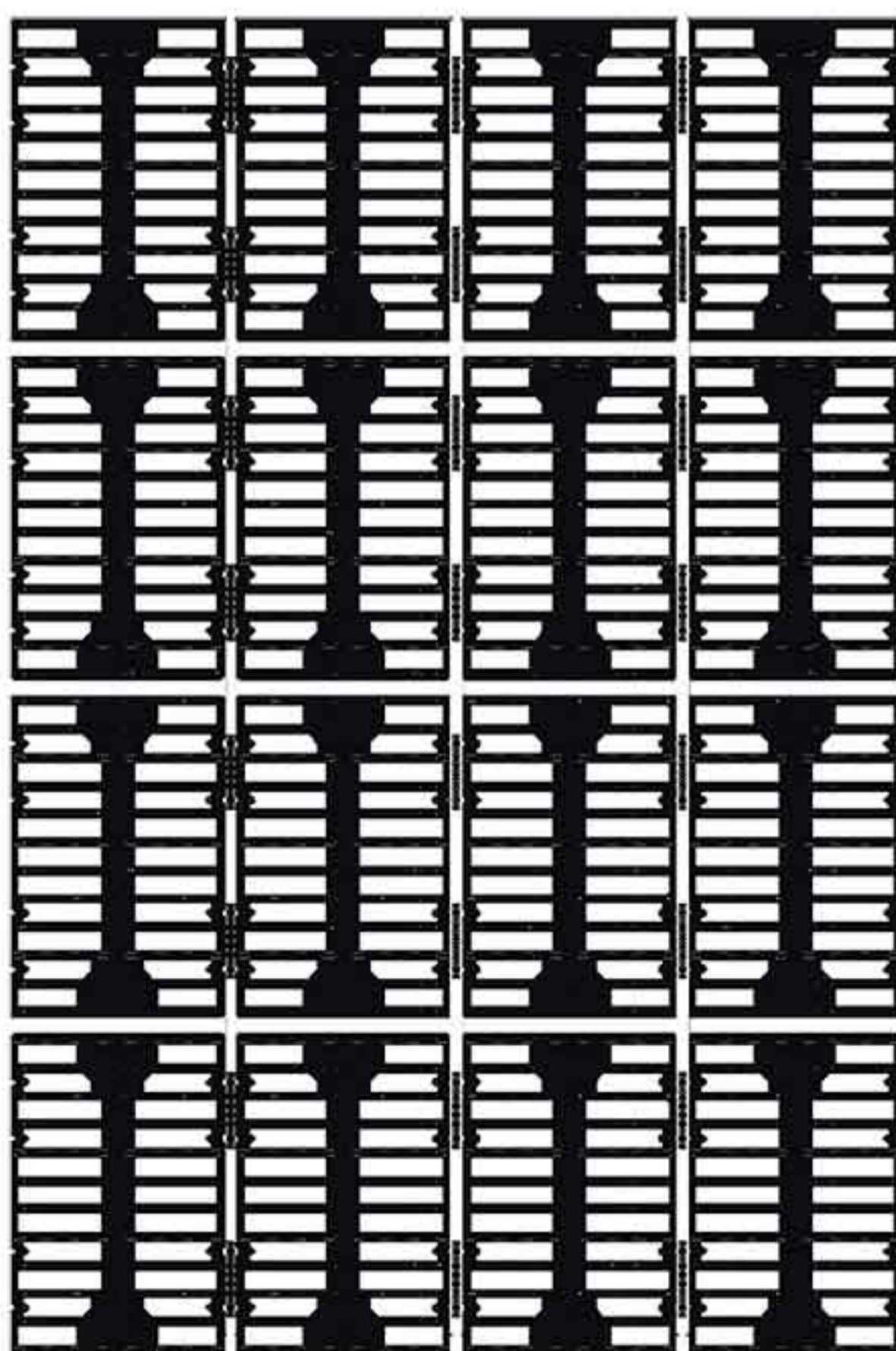

◀ **High bearing capacity**

Each led module has 2pcs 3-5mm  $\varphi$  steel wires, maximum bearing capacity 700kg, maximum 250 height





## ► Standardized installation structure

The screen is light, only 15 kg/m<sup>2</sup>, and thin, thickness is only 23.5 mm, minimize installation structure and minimize impact on buildings. Easy and quick to install, training is simple. Outdoor displays can be installed in batches.

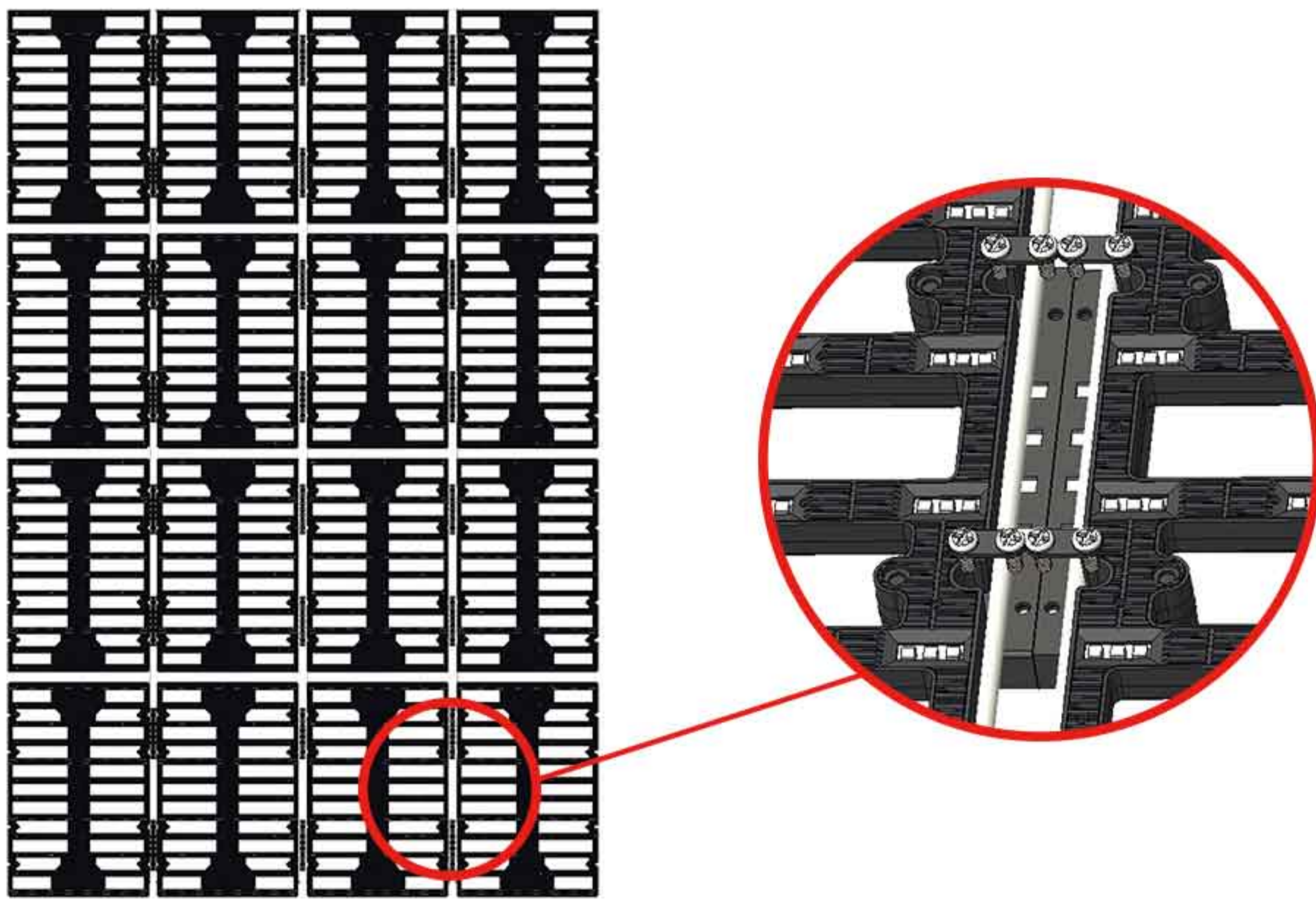
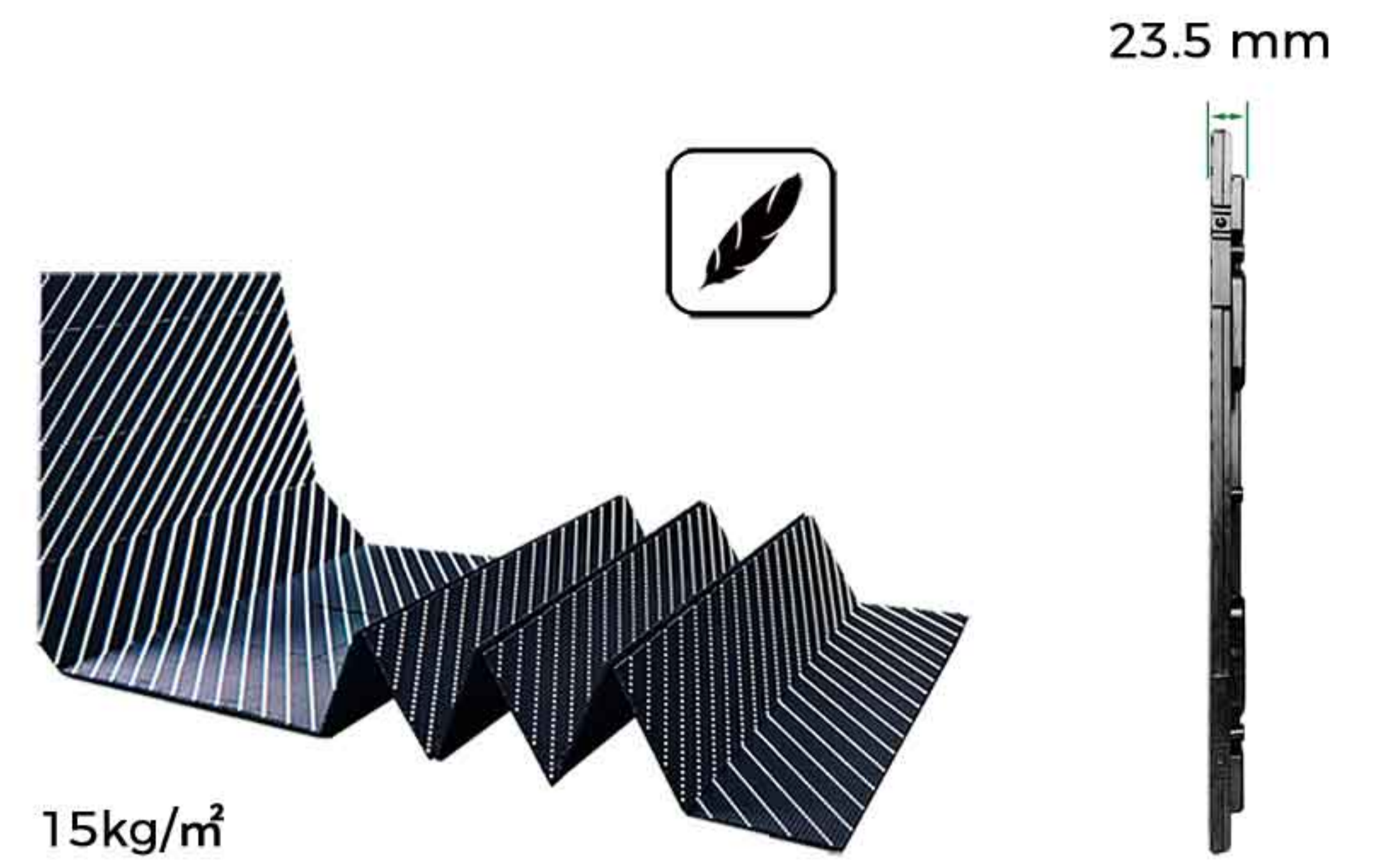

## ◀ Front and back maintenance

Front and back maintenance  
Front or back maintenance accessible, depending on how it is installed.

## ► High protection level

Glue filling on double-sided unit board to be completely waterproof, IP65.  
100% immersion aging test before shipment.



## ◀ High reliability

No connectors and low heating are to ensure the screen is stable.  
Reliable work, basically no maintenance in 2-3 years, extended warranty for up to five years(except led lamp)



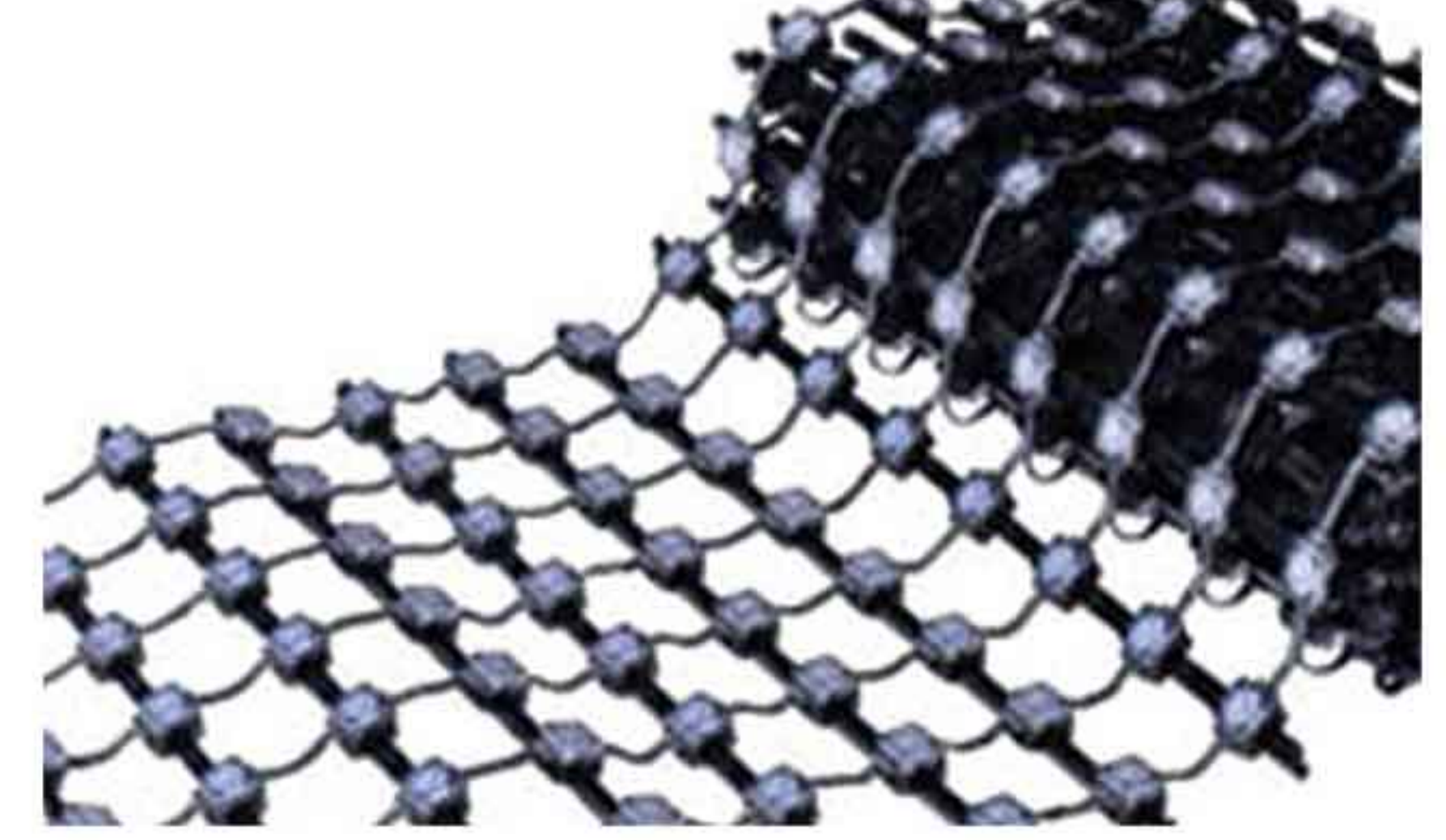

- | Transparency 56%
- | Built-in multiple sturdy steel wires, safe hanging 20-40 meters is no problem.
- | The module has built-in DCDC, which converts the high-voltage to low-voltage to supply power to the ICs and lamps, the heat generation is extremely low. The maximum load can be as long as 25-30 meters at 6000nits.
- | Signal transmission bandwidth up to 120 Mbps, large bandwidth, can load 50-70 meters.

- | Transparency 54%
- | The steel wire is thin, and the height exceeds 10 meters to be additionally reinforced.
- | Each driver chip has a built-in LDO to convert the high voltage to a low voltage to power the IC. The lamps are still directly powered by the high voltage.
- | The signal transmission bandwidth is up to 0.8 Mbps, which loads 5-8 meters

## Smart-T

## led dots P40

### Surface Smooth and Viewing Angle

The maximum error of screen surface is 3mm. Visual effect from side view is great.  
 Horizontal Viewing Angle H165°±5°  
 Vertical Viewing Angle V120°±5°

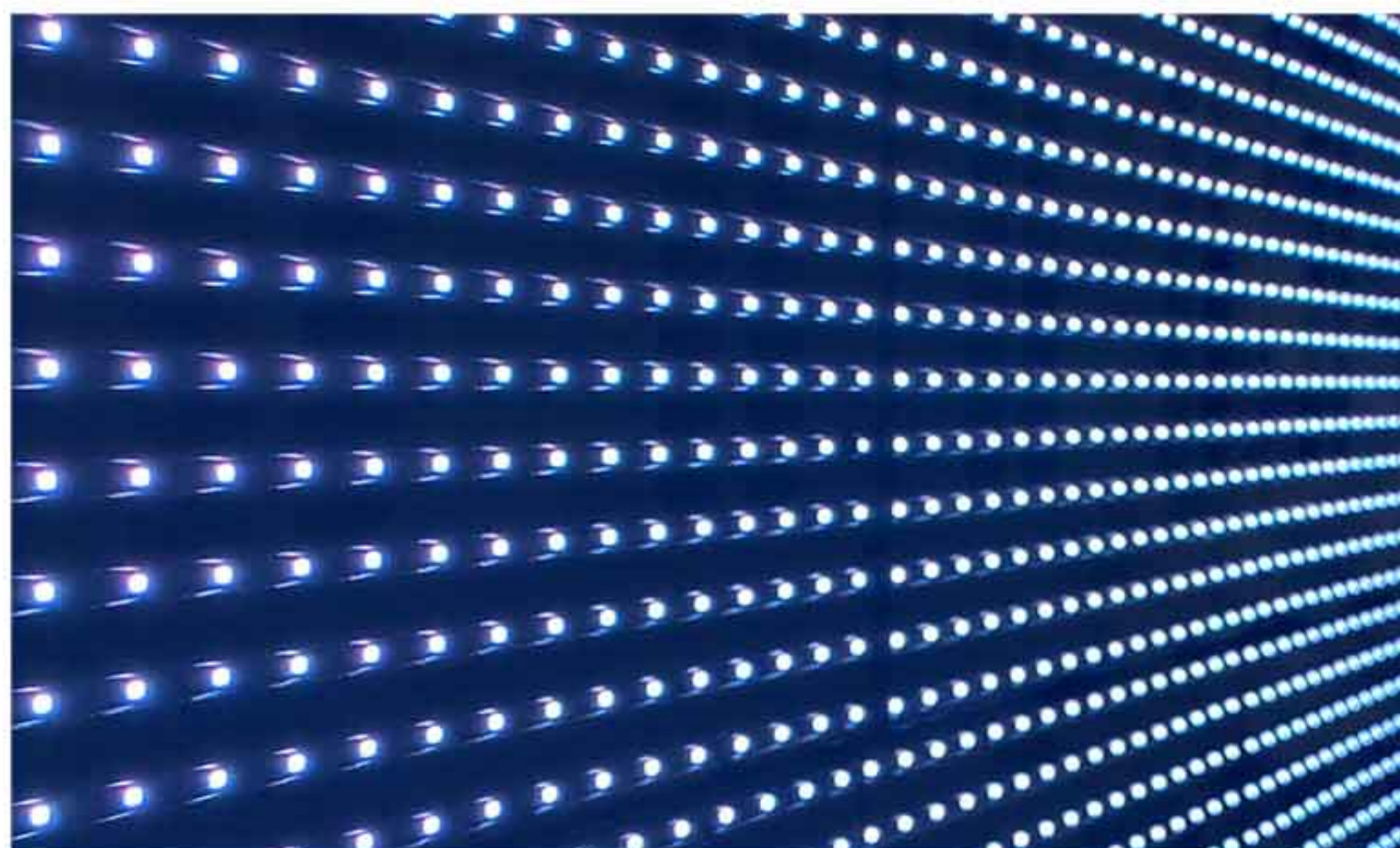

### Surface Smooth and Viewing Angle

The screen surface is uneven, the average error exceeds 10mm. View effect of side view is poor.  
 Horizontal Viewing Angle 110°  
 Vertical Viewing Angle 110°



### Display effect

Use LED display driver IC, good display effect.  
 Gray Scale: 16 bits \* 16bits \* 16bits  
 Color display digits: 65536



### Display effect

Use architectural decoration lighting chip, display effect is average.  
 Gray Scale: 12 bits \* 12bits \* 12bits  
 Color display digits: 4096





### Dynamic folding

The maximum folding times of the screen exceeds 120,000 times, the lamps and cables are still intact. The product has been sold for 8 years, the actual dynamic folding application cases exceed 100.



### Dynamic folding

Led dot products cannot meet dynamic folding applications, dots will hook each other during folding.



## Applications: Media Facade



Mall



buidling



4S shop



Water project



Cultural Tourism Project



Concert



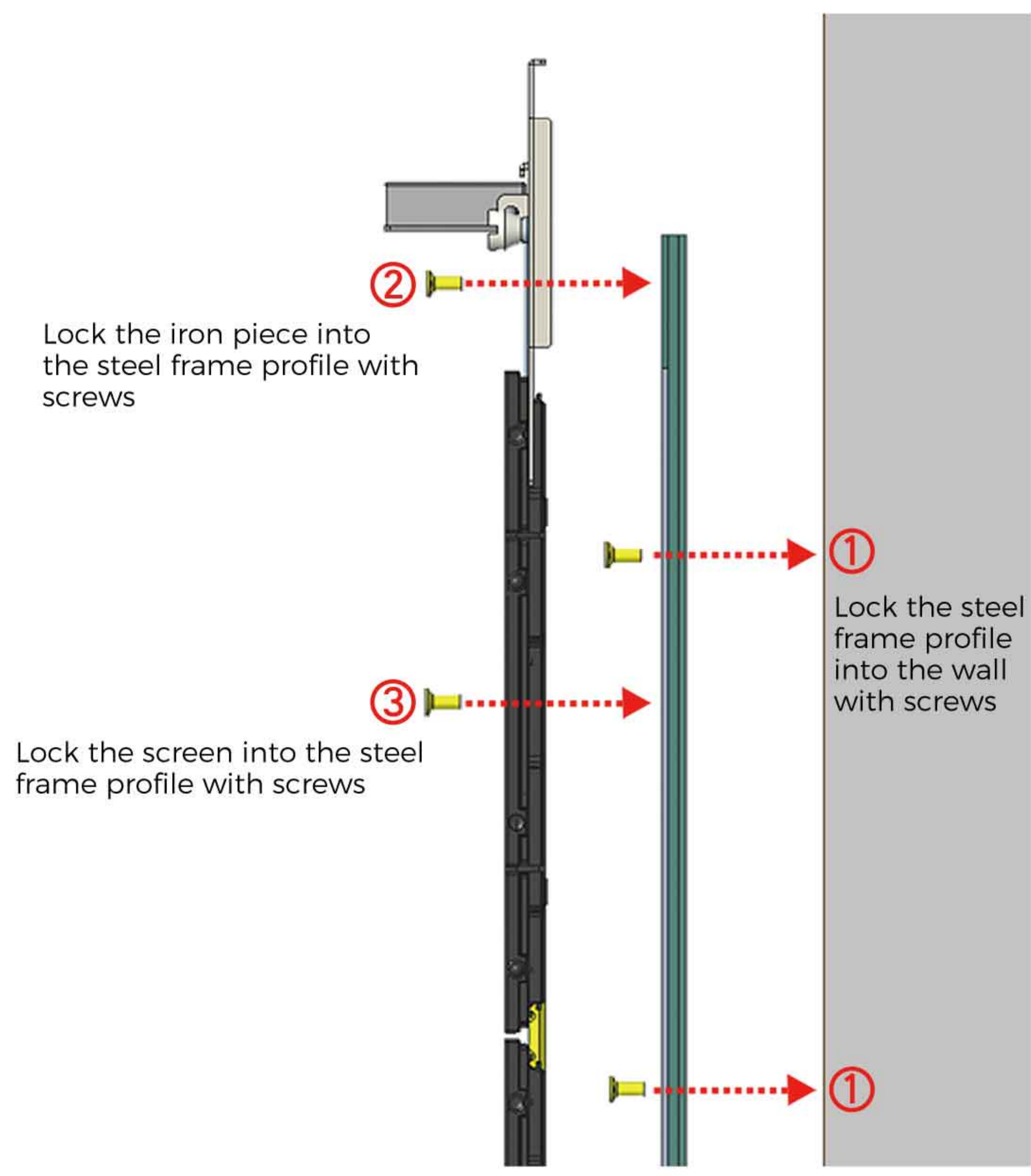
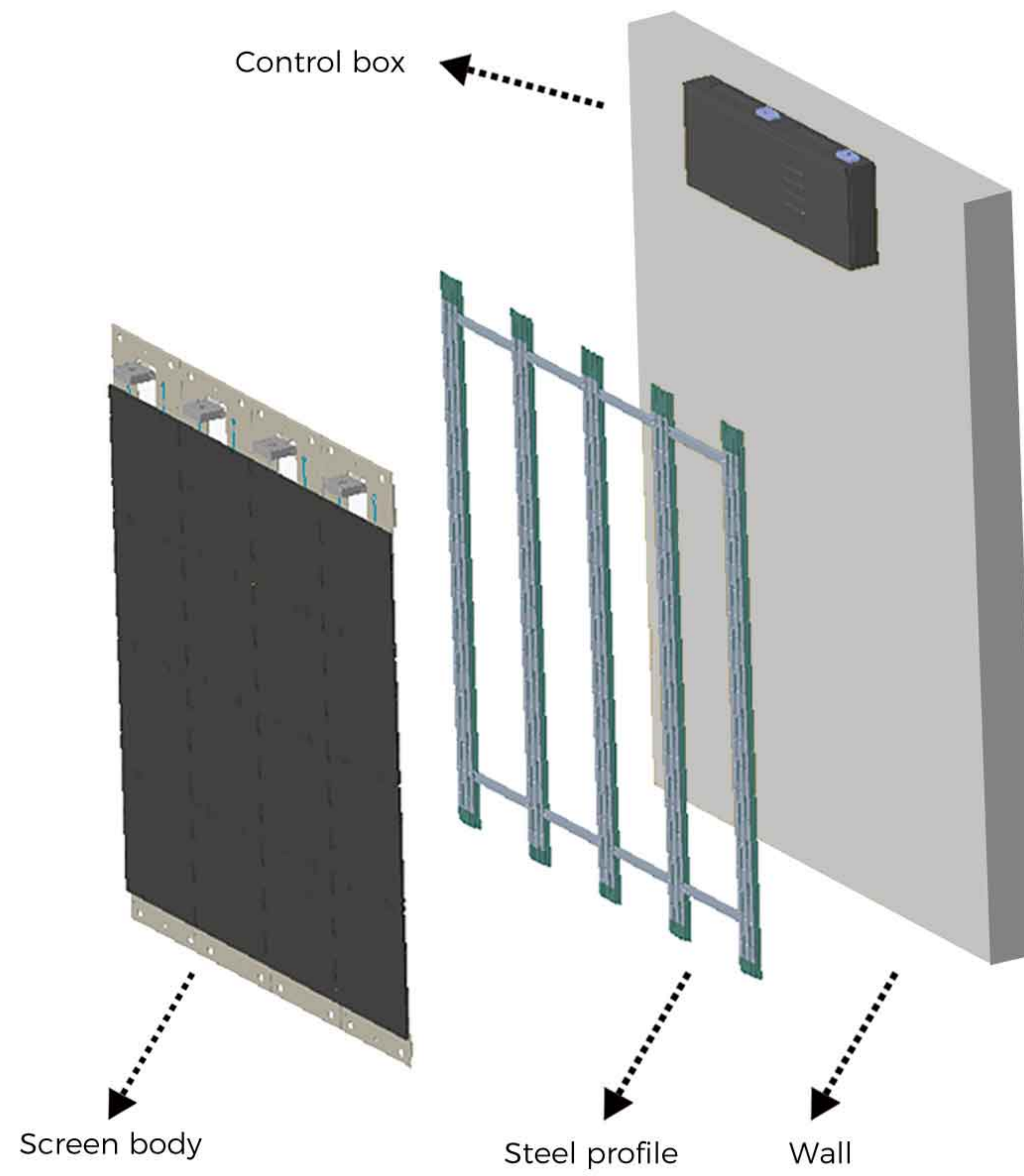

Installation steps



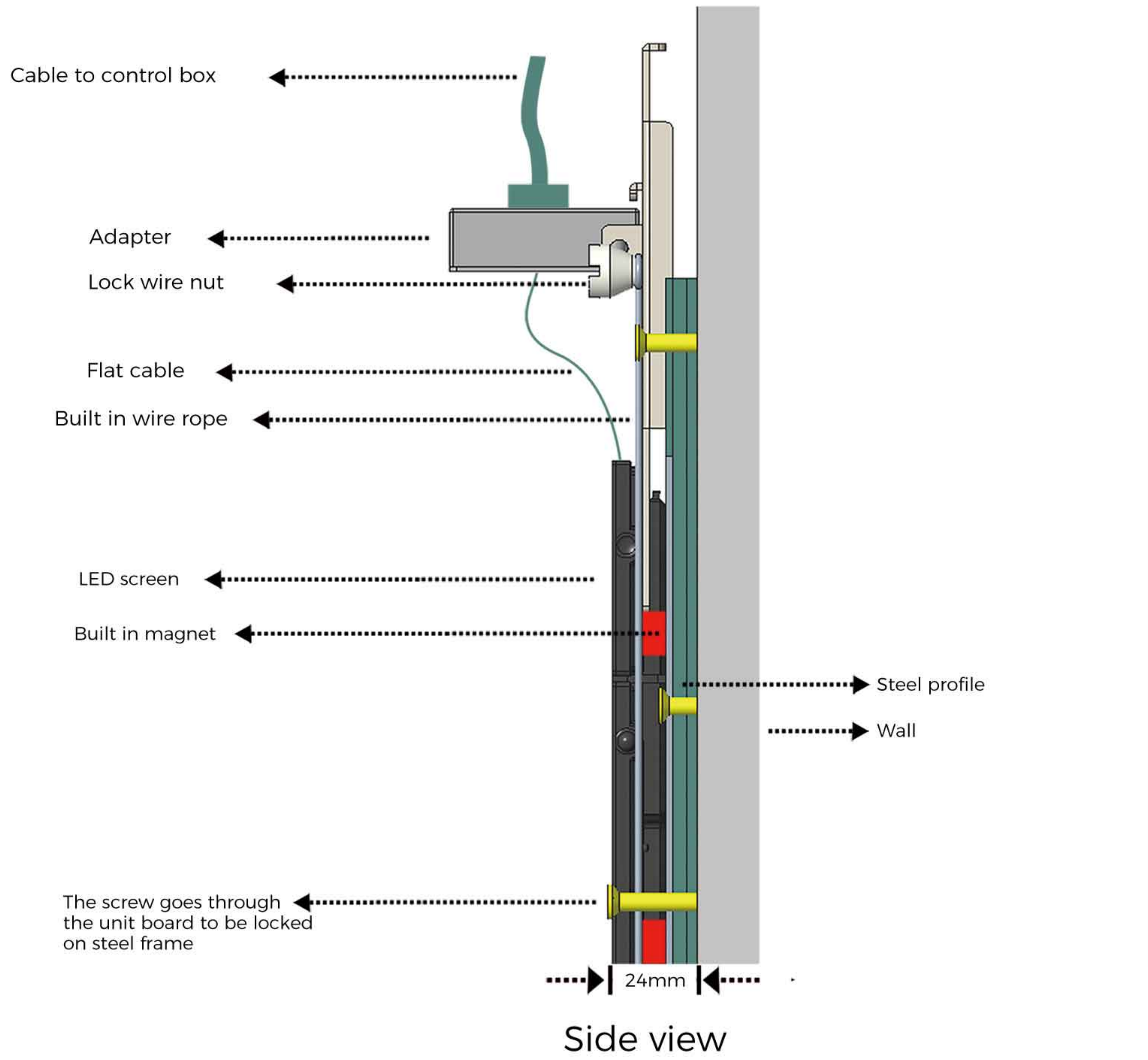



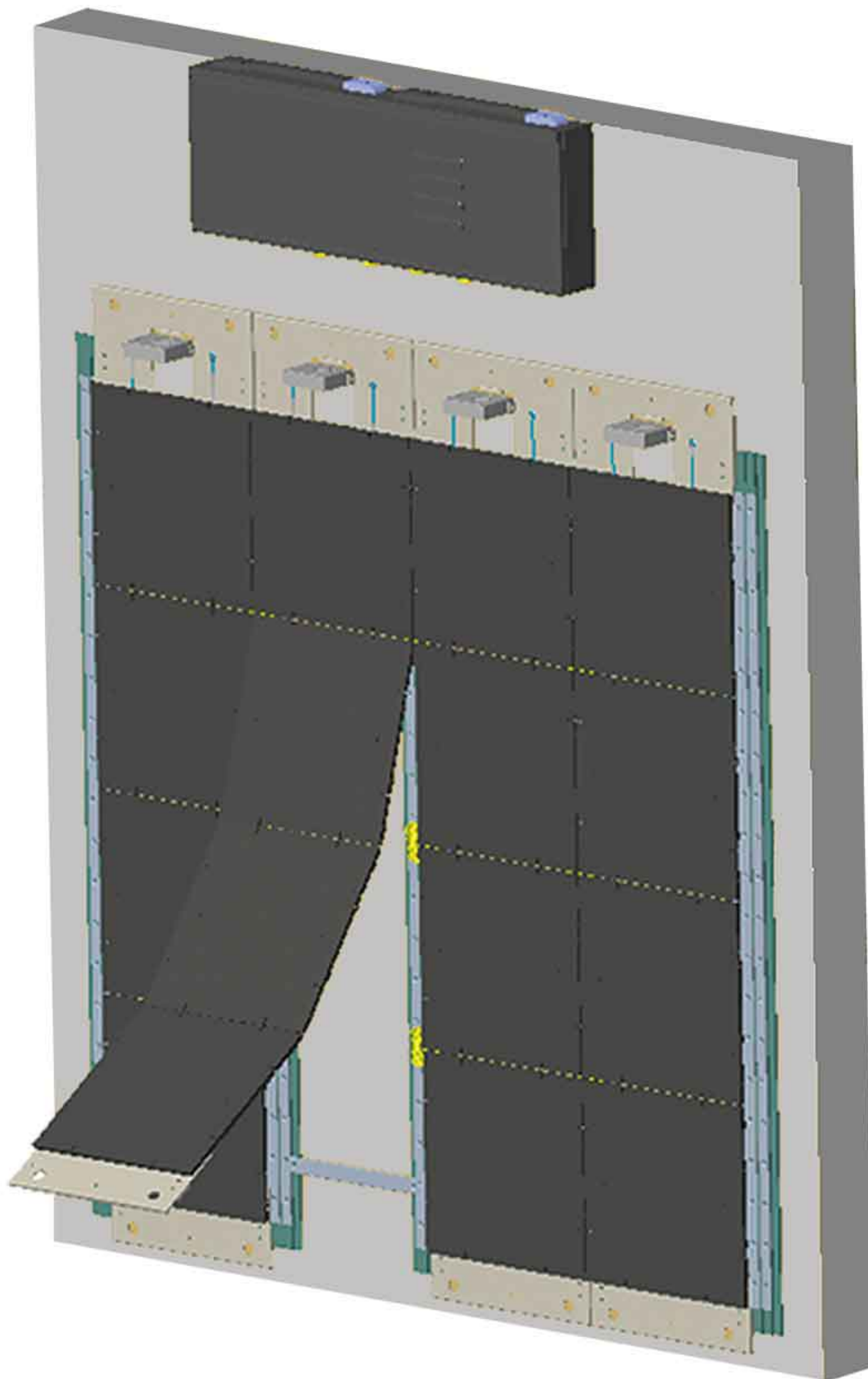

The whole row of led panels can be removed from the front for maintenance

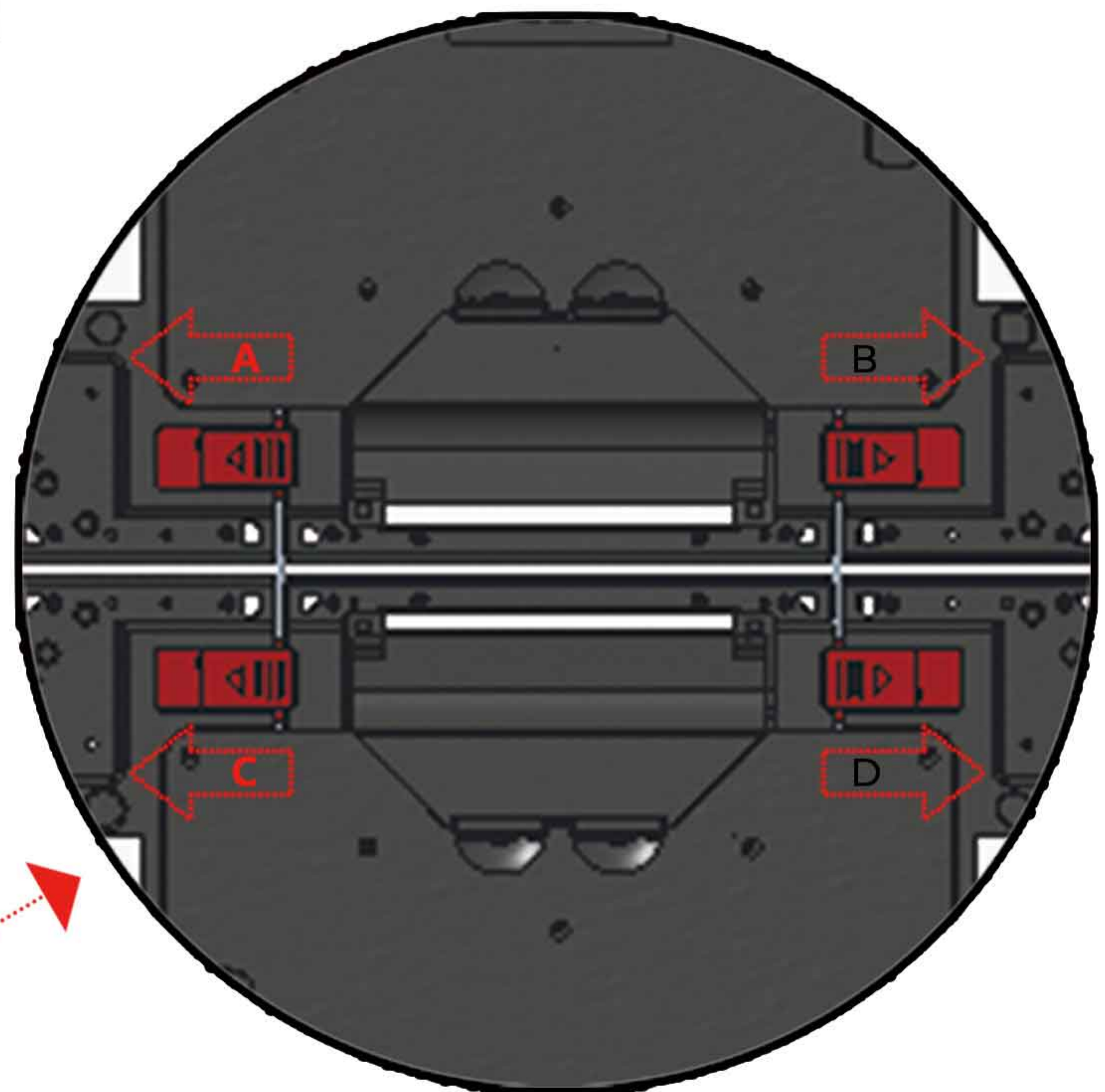
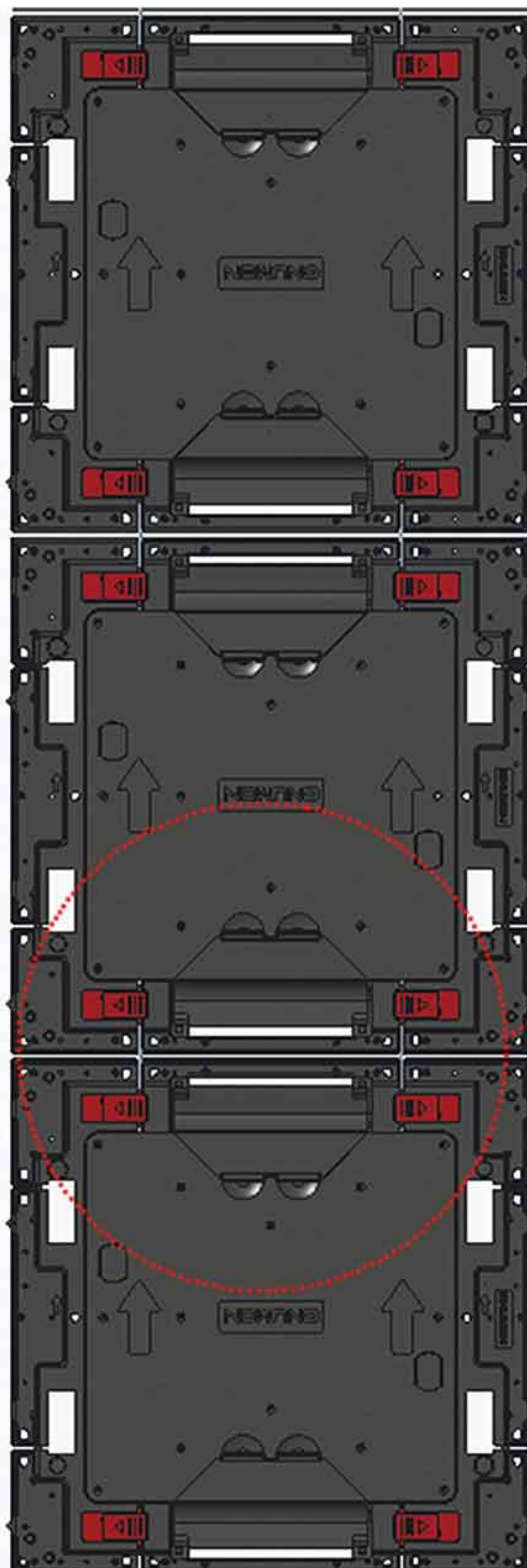

Steel wire sliding buckle and built-in connector design ensure quick replacement of led module



The unit board has built-in receiving card, which can be installed into large screen.

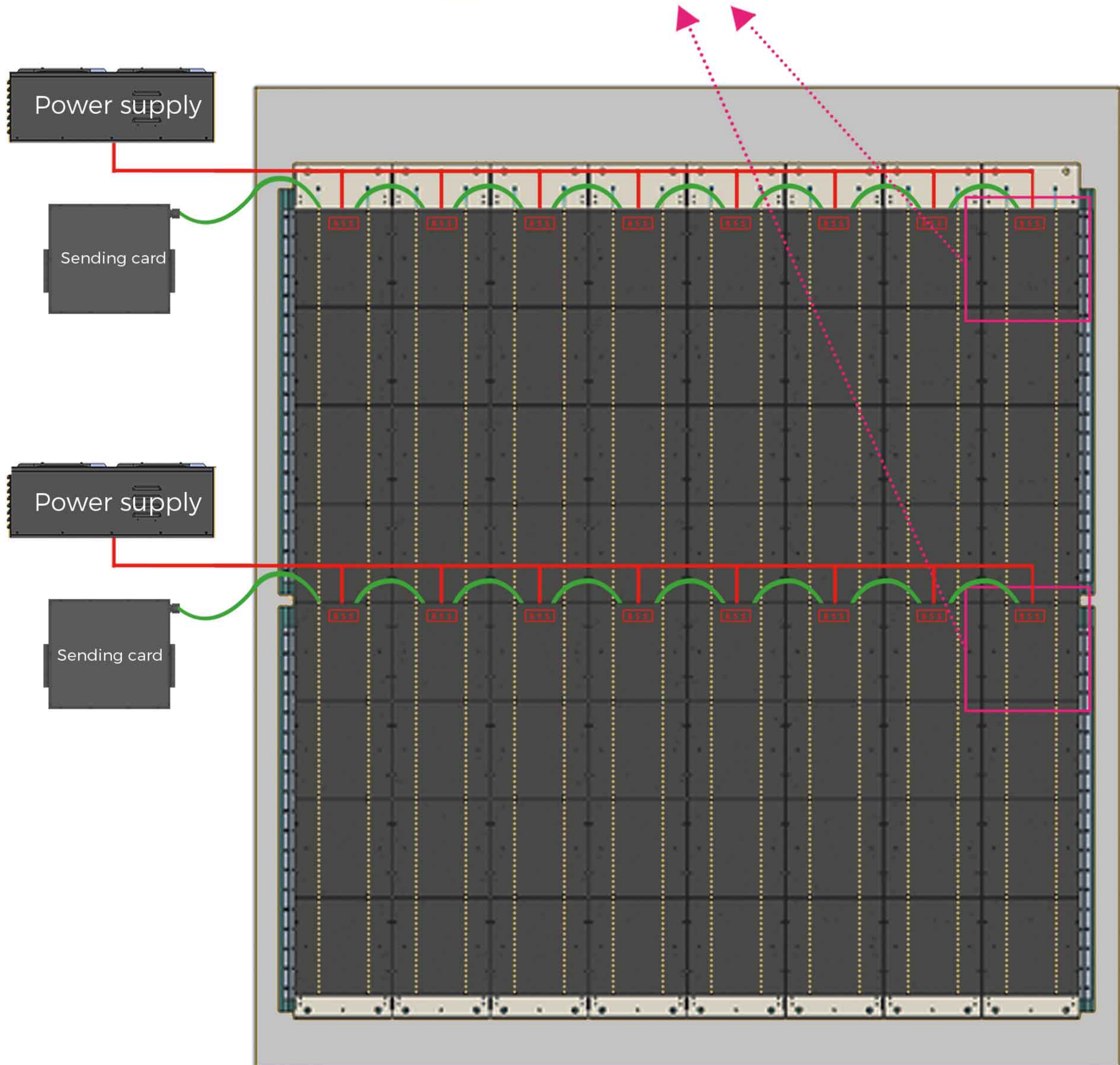
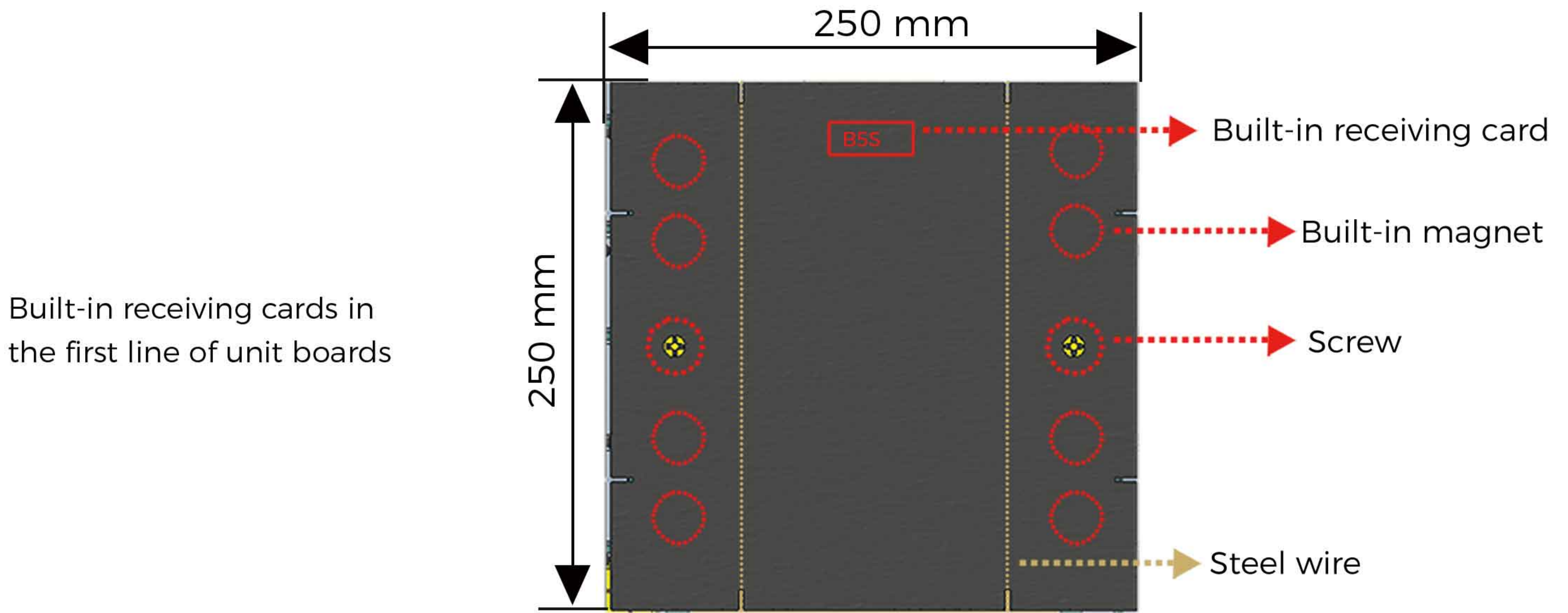



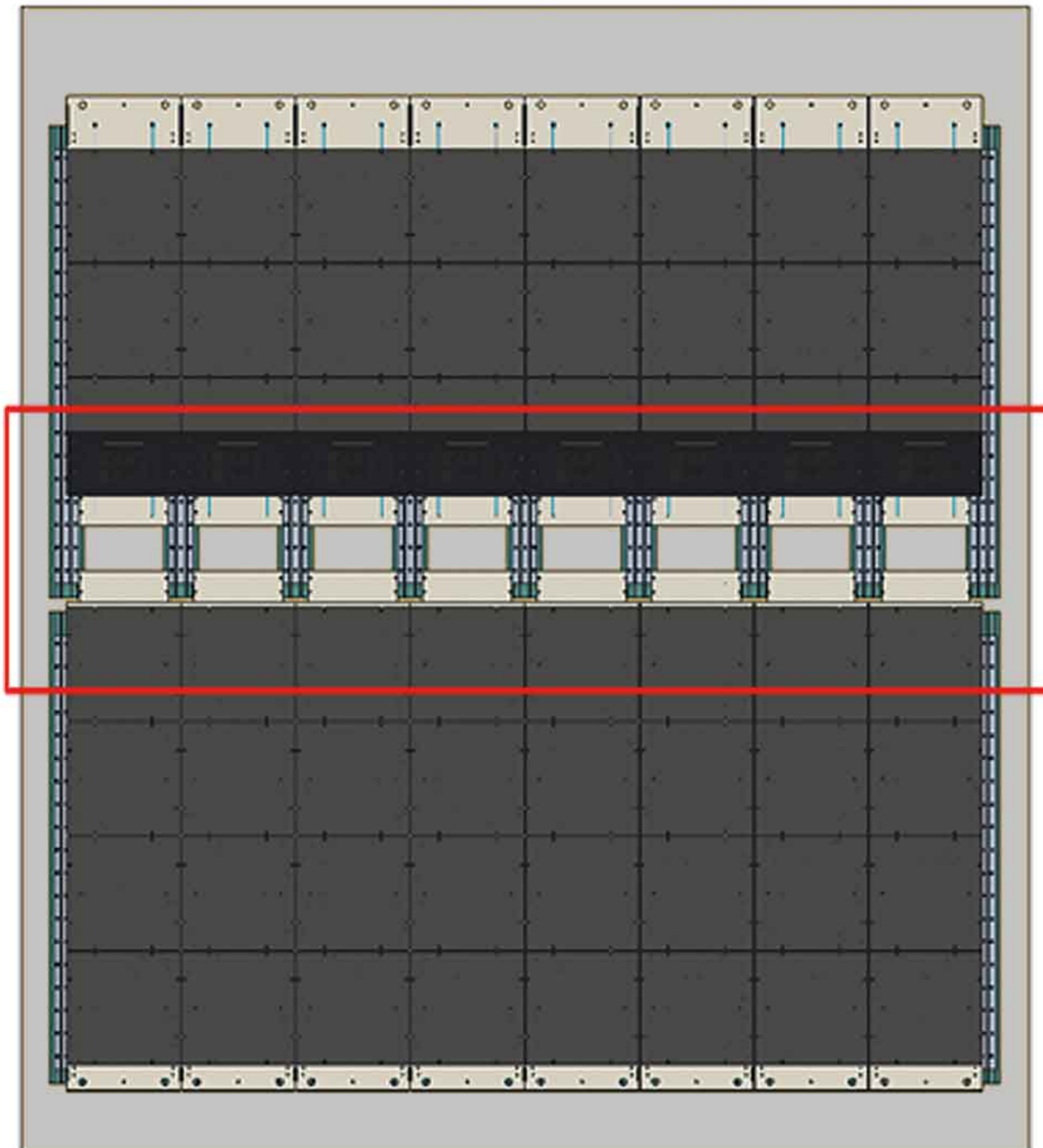

Raise the last row of unit plates

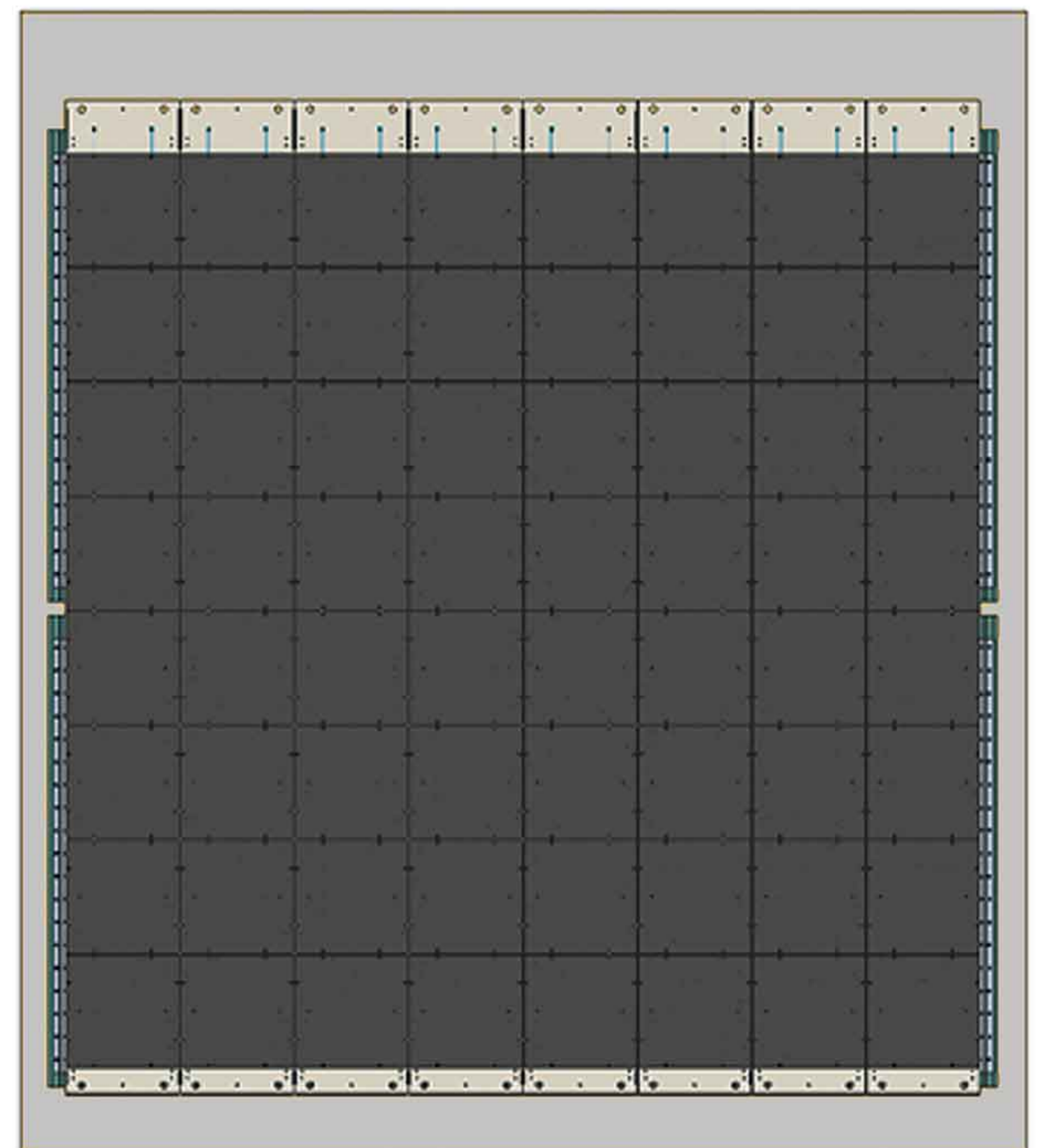
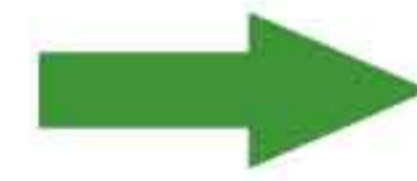
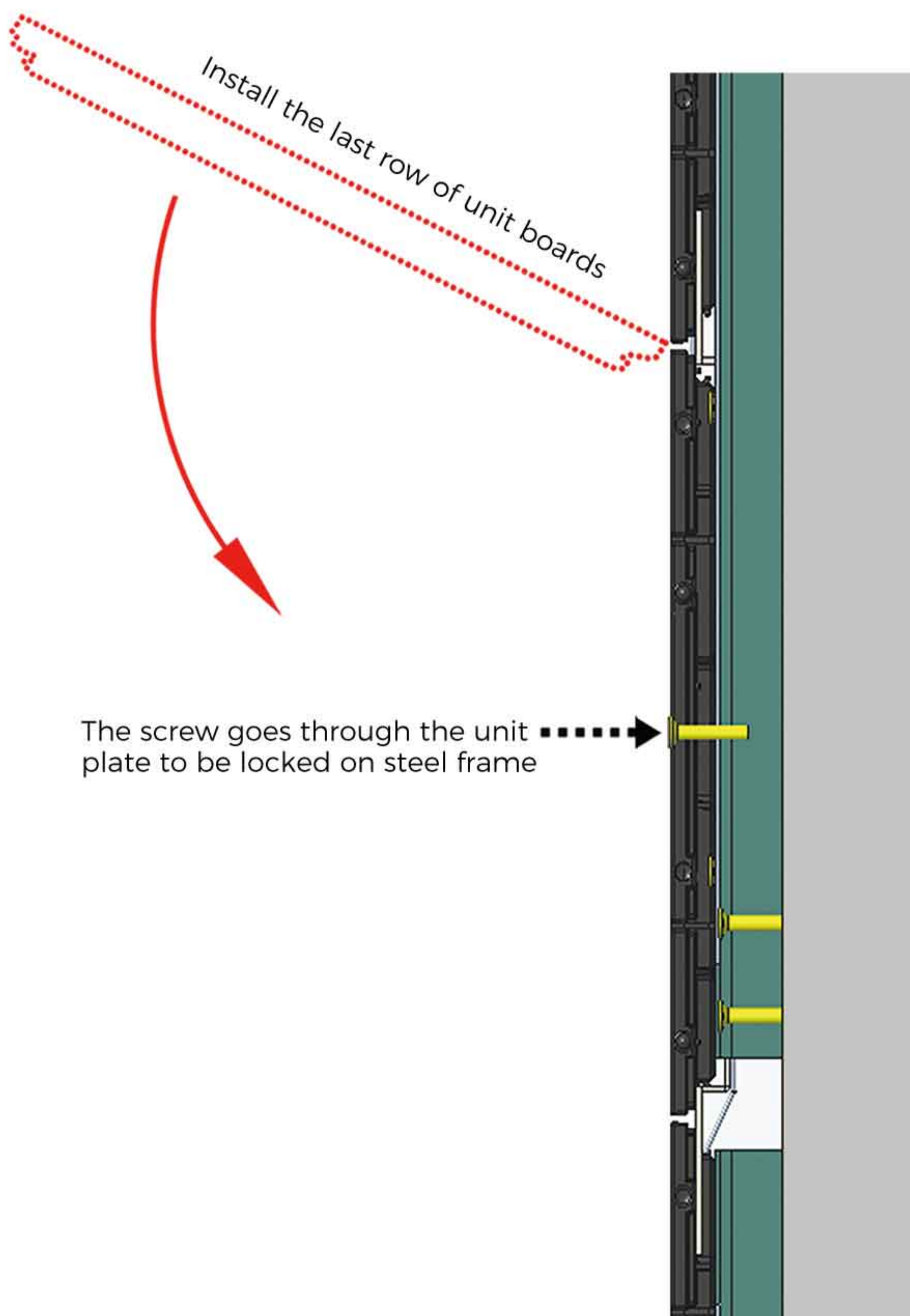
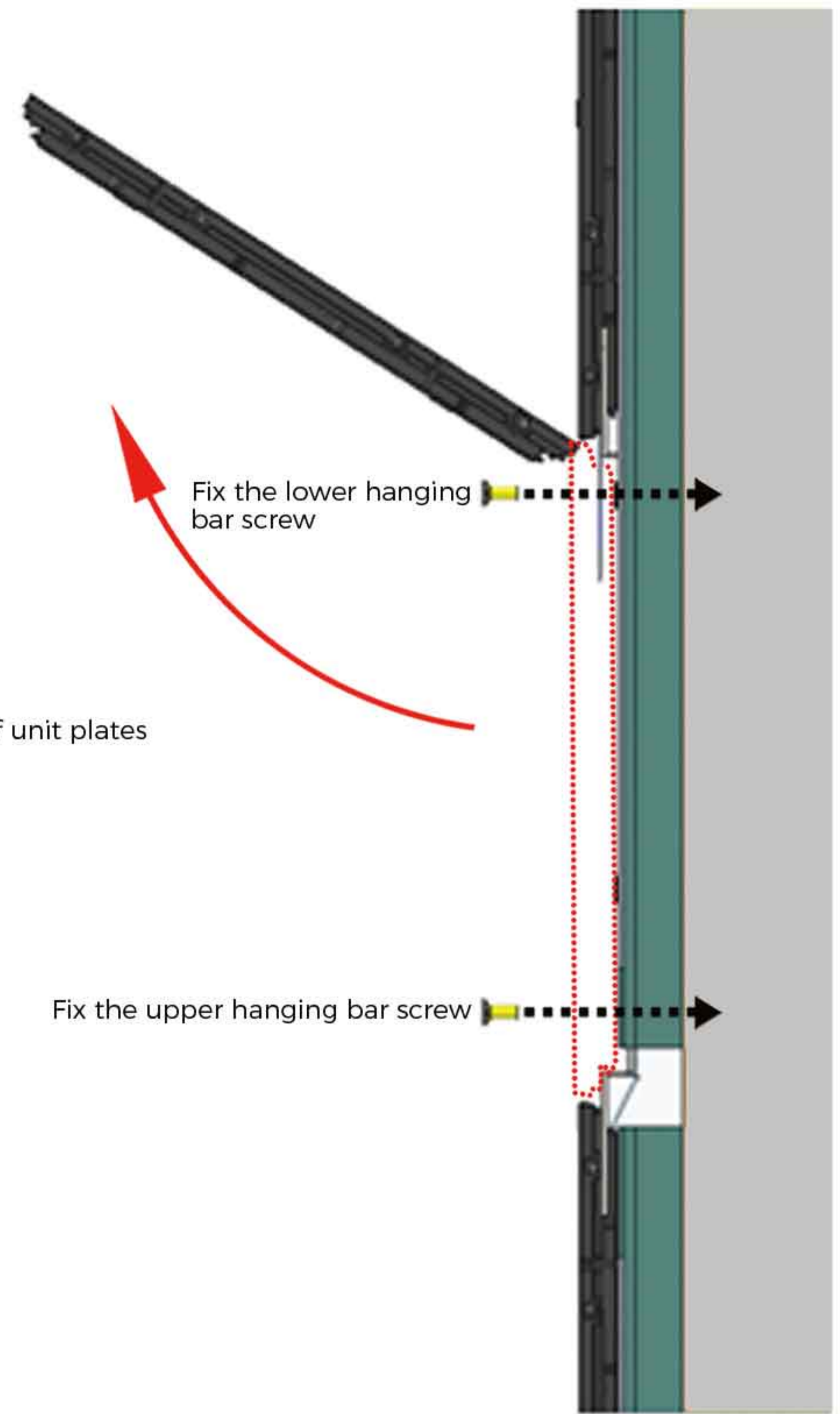



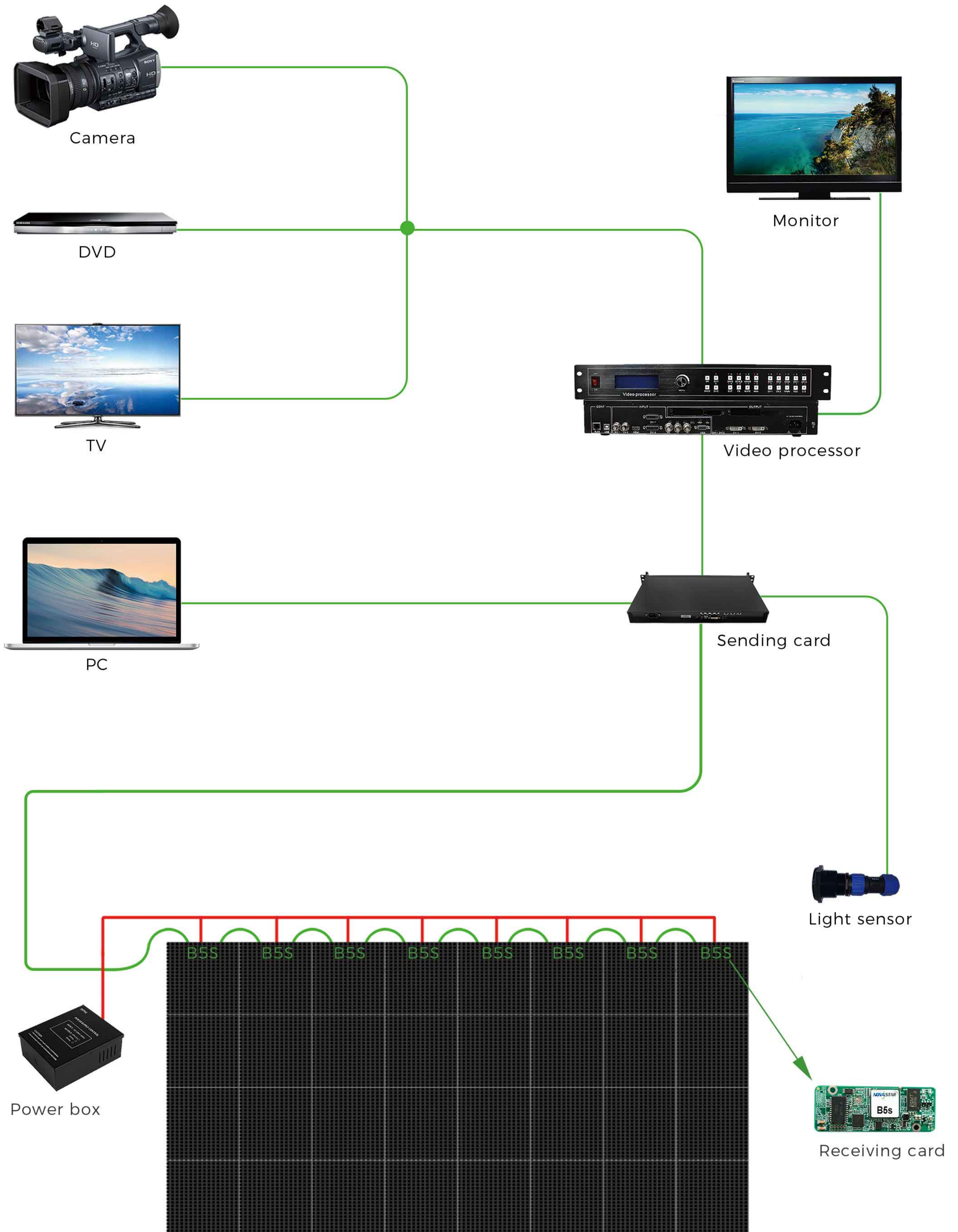



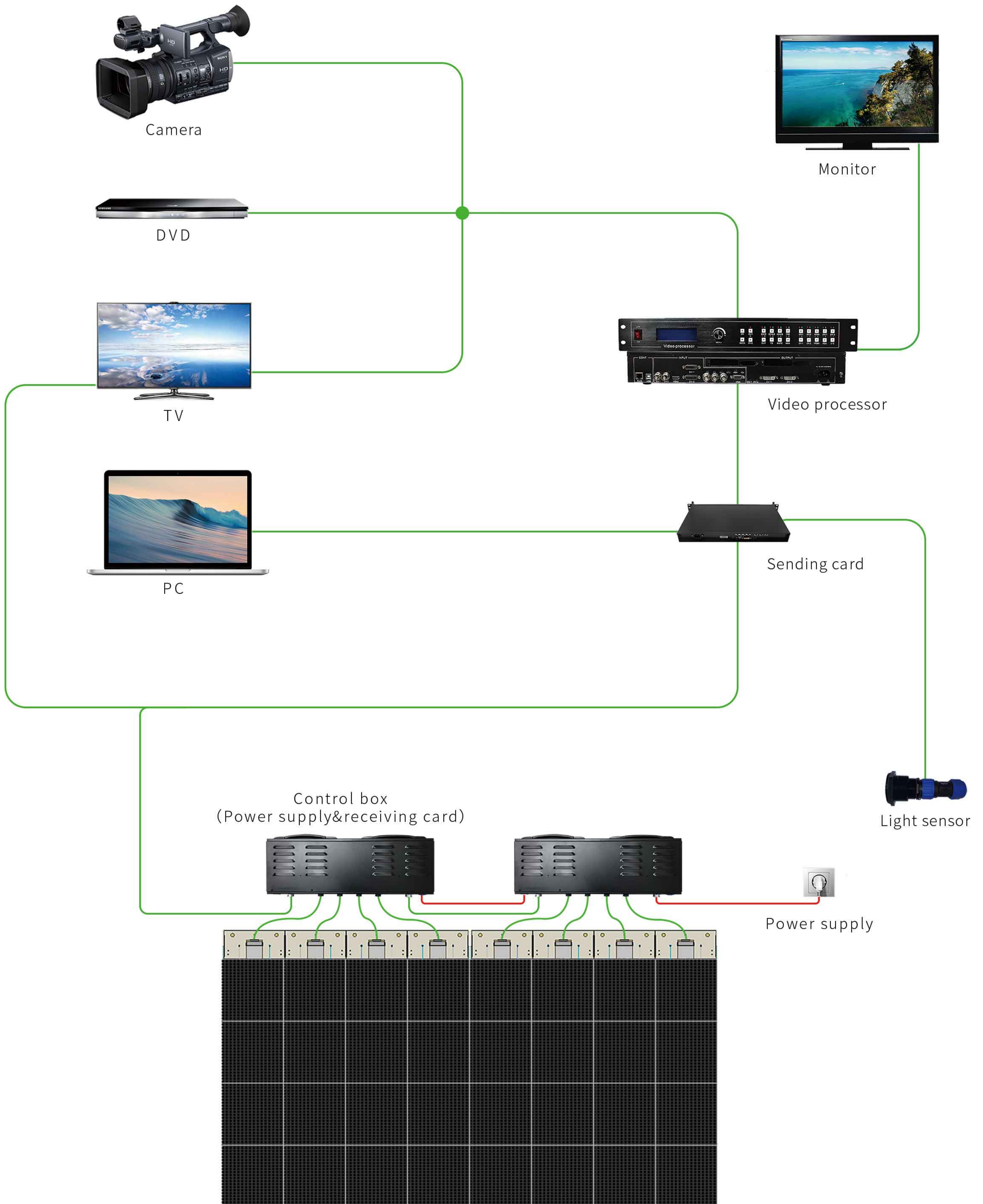



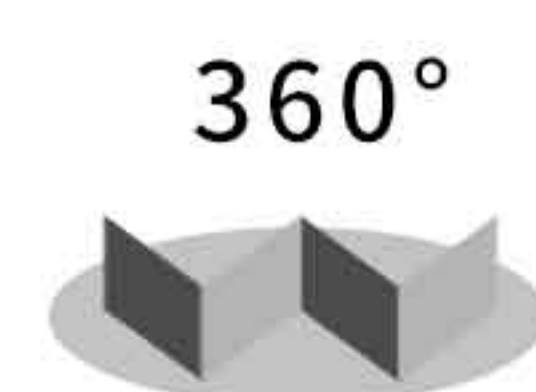
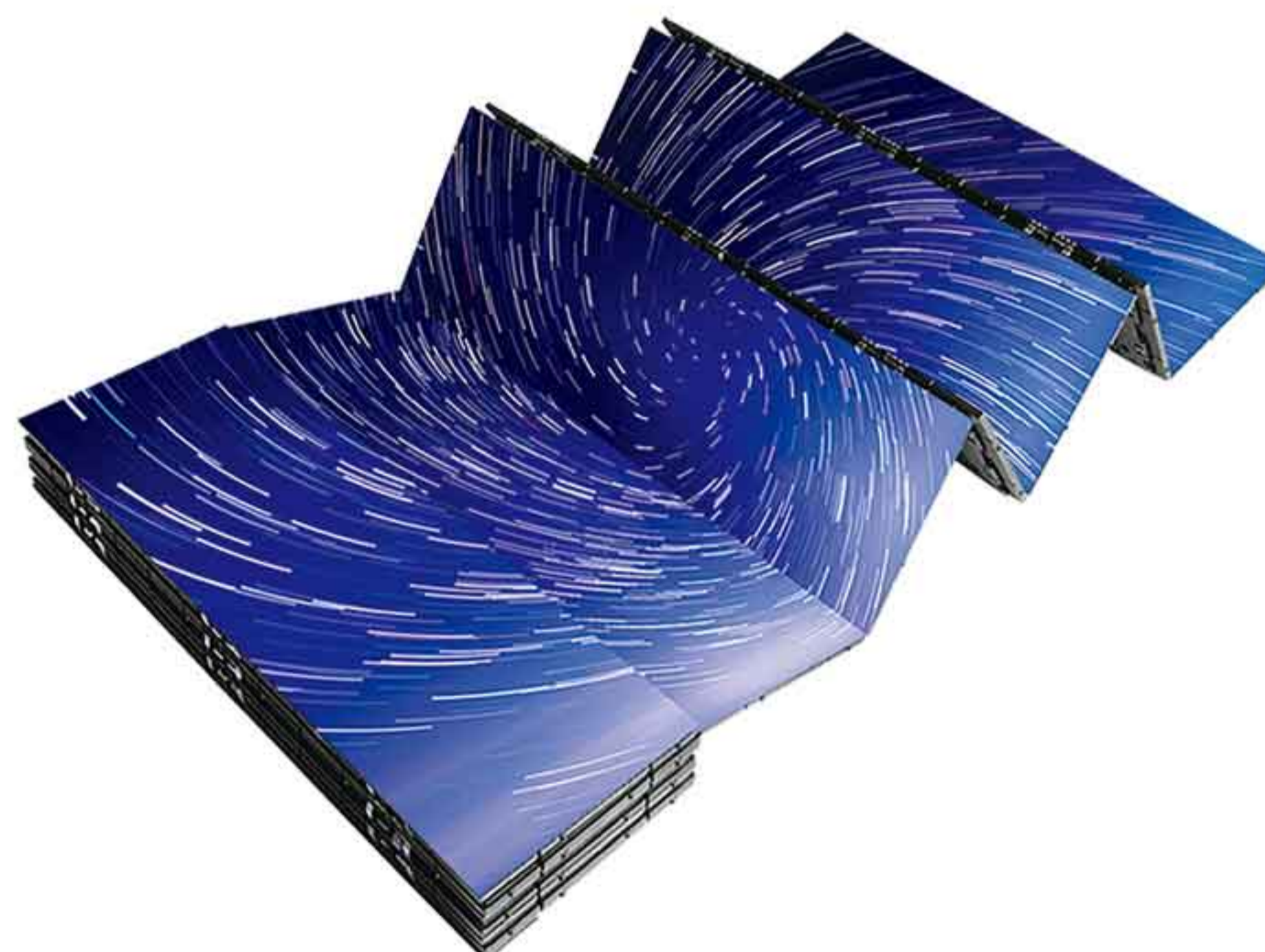
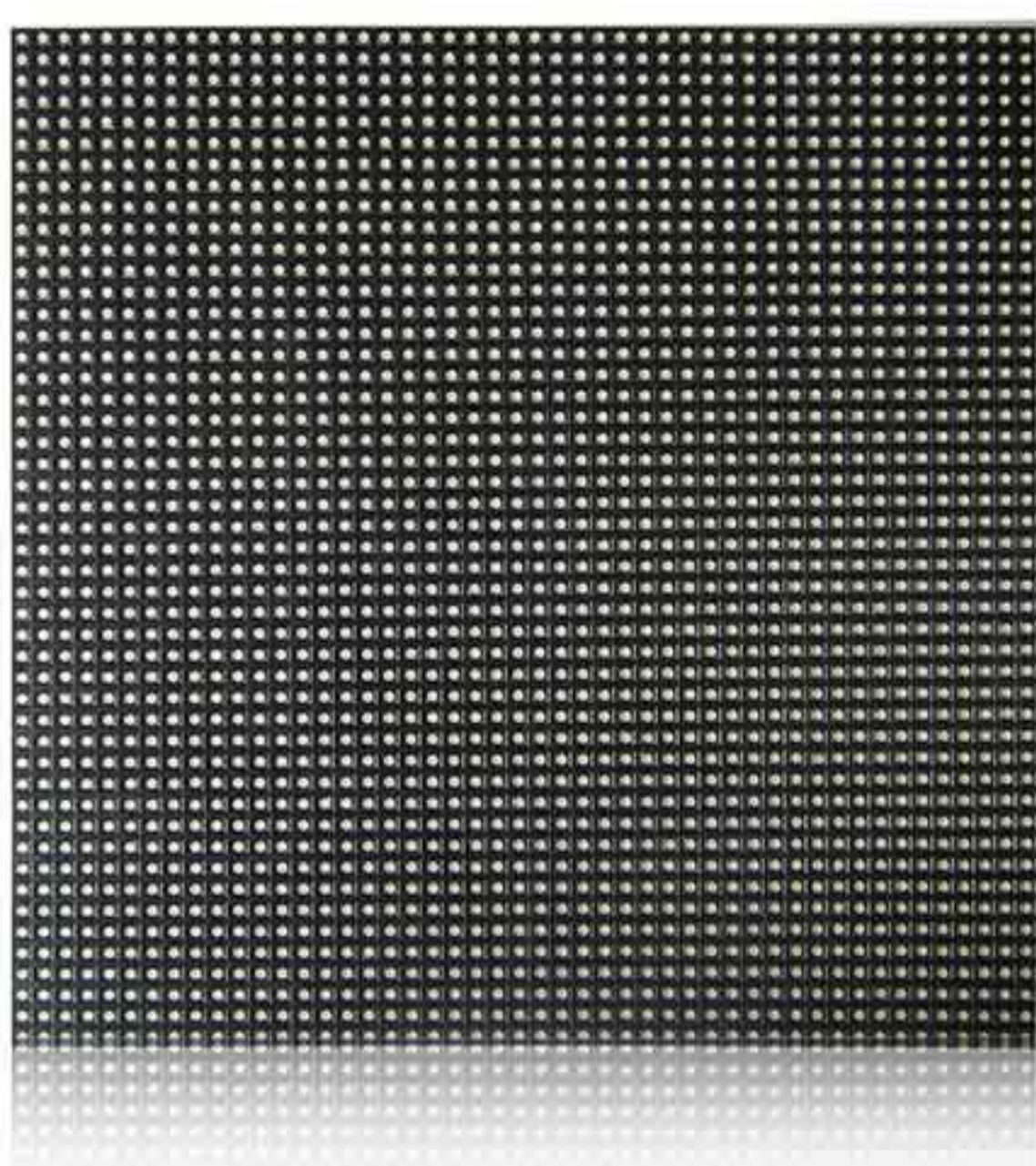

## Smart plus FCS 360° foldable

Application Environment		Outdoor			
Model		Smart plus 5	Smart plus 7	Smart plus 10	Smart plus 15
Pixel Pitch	(mm)	5.2	7.8	10.4	15.6
IP Rating		IP65	IP65	IP65	IP65
LED Type		SMD 1415	SMD 2727	SMD 2727	SMD 2727
Pixel Density	(pixel/m <sup>2</sup> )	36864	16384	9216	4096
Driving Mode		1/12	1/4	1/4	1/2
Gray Scale	(bit)	16	16	16	16
Max Brightness (golden wire led)	(nits)	6000	6000	6000	6000
Max Power Consumption (cooper wire led)	(w/m <sup>2</sup> )	830	750/560	560	560
Max Refresh Rate	(Hz)	5000	8000	8000	8000
Module Resolution	(pixels)	48 * 48	32 * 32	24 * 24	16 * 16
Module Size	(mm)	250 * 250	250 * 250	250 * 250	250 * 250
Screen Thickness	(mm)	15	16.5	16.5	16.5
Weight	(kg/m <sup>2</sup> )	12	12	12	12
Folding Angle		360°	360°	360°	360°
Viewing Angle	(H/V)	120° / 120°	120° / 120°	120° / 120°	120° / 120°
Output Voltage	(V)	DC24/48	DC24/48	DC24/48	DC24/48
Input Voltage	(V)	AC100 ~ AC240	AC100 ~ AC240	AC100 ~ AC240	AC100 ~ AC240
Maximum load height of single control box	(m)	8	12	16	24
Best Viewing Distance	(m)	≥5	≥8	≥10	≥15
Brightness adjustment (digital)	(levels)	256	256	256	256
Brightness adjustment (analog current)	(levels)	64-256	64-256	64-256	64-256
Contrast		2500:1	2500:1	2500:1	2500:1
Connection Type	(standard) (spare)	2+14pin Soldering 50pin Connector	2+14pin Soldering 50pin Connector	2+14pin Soldering 50pin Connector	2+14pin Soldering 50pin Connector
Short Circuit Protection		Yes	Yes	Yes	Yes
Quick Maintenance		Yes	Yes	Yes	Yes
Controlling Mode		synchronous asynchronous	synchronous asynchronous	synchronous asynchronous	synchronous asynchronous
Installation Method		Hanging Magnet mounting	Hanging Magnet mounting	Hanging Magnet mounting	Hanging Magnet mounting
Operation temperature	(°C)	-40 ~ 65	-40 ~ 65	-40 ~ 65	-40 ~ 65
Operation humidity	(RH)	0% ~ 90%	0% ~ 90%	0% ~ 90%	0% ~ 90%
Certificate					





## Magic plus FPS 180° foldable

Application Environment		Outdoor		
Model		Magic plus 3	Magic plus 5	Magic plus 7
Pixel Pitch	(mm)	3.9	5.2	7.8
IP Rating		IP65	IP65	IP65
LED Type		SMD 1921	SMD 2727	SMD 2727
Pixel Density	(pixel/m <sup>2</sup> )	65536	36864	16384
Driving Mode		1/16	1/12	1/4
Gray Scale	(bit)	16	16	16
Max Brightness (cooper wire led)	(nits)	7000	6000	8000
Max Brightness (golden wire led)	(nits)	8500	7200	9500
Max Power Consumption (cooper wire led)	(w/m <sup>2</sup> )	880	670	880
Max Power Consumption (golden wire led)	(w/m <sup>2</sup> )	900	660	900
Max Refresh Rate	(Hz)	4000	5000	8000
Module Resolution	(pixels)	64 * 64	48 * 48	32 * 32
Module Size	(mm)	250 * 250	250 * 250	250*250
Screen Thickness	(mm)	15	16.5	16.5
Weight	(kg/m <sup>2</sup> )	12.5	12.5	12.5
Folding Angle		180 °	180 °	180 °
Viewing Angle	(H/V)	120° / 120°	120° / 120°	120° / 120°
Output Voltage	(V)	DC24/48	DC24/48	DC24/48
Input Voltage	(V)	AC100 ~ AC240	AC100 ~ AC240	AC100 ~ AC240
Maximum load height of single control box	(m)	6	8	12
Best Viewing Distance	(m)	≥4	≥5	≥8
Brightness adjustment (digital)	(levels)	256	256	256
Brightness adjustment (analog current)	(levels)	64-256	64-256	64-256
Contrast		2500:1	2500:1	2500:1
Connection Type	(standard) (spare)	2+14pin Soldering 50pin Connector	2+14pin Soldering 50pin Connector	2+14pin Soldering 50pin Connector
Short Circuit Protection		Yes	Yes	Yes
Quick Maintenance		Yes	Yes	Yes
Controlling Mode		synchronous asynchronous	synchronous asynchronous	synchronous asynchronous
Installation Method		Hanging Magnet mounting	Hanging Magnet mounting	Hanging Magnet mounting
Operation temperature	(C°)	-40 ~ 65	-40 ~ 65	-40 ~ 65
Operation humidity	(RH)	0% ~ 90%	0% ~ 90%	0% ~ 90%
Certificate				

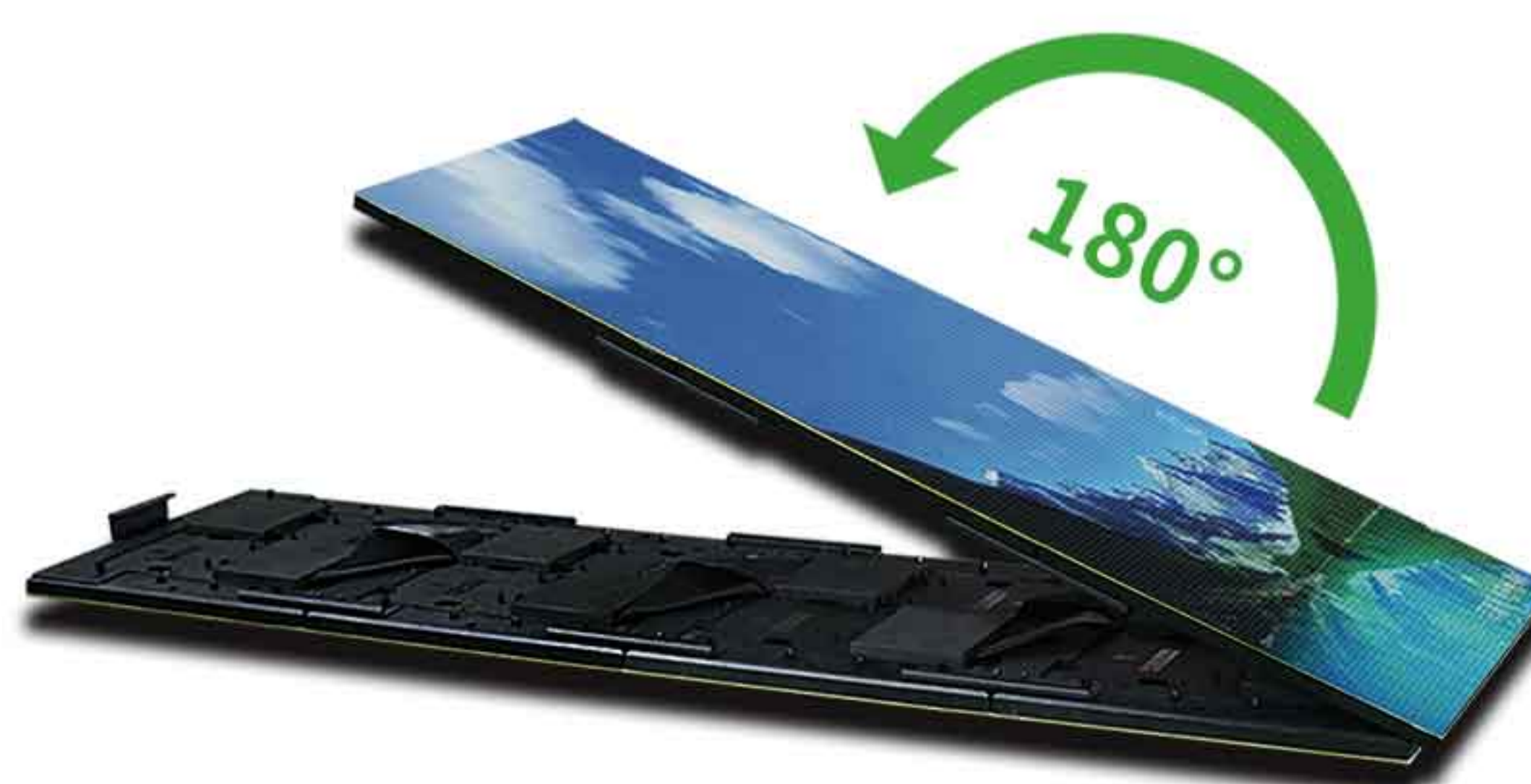
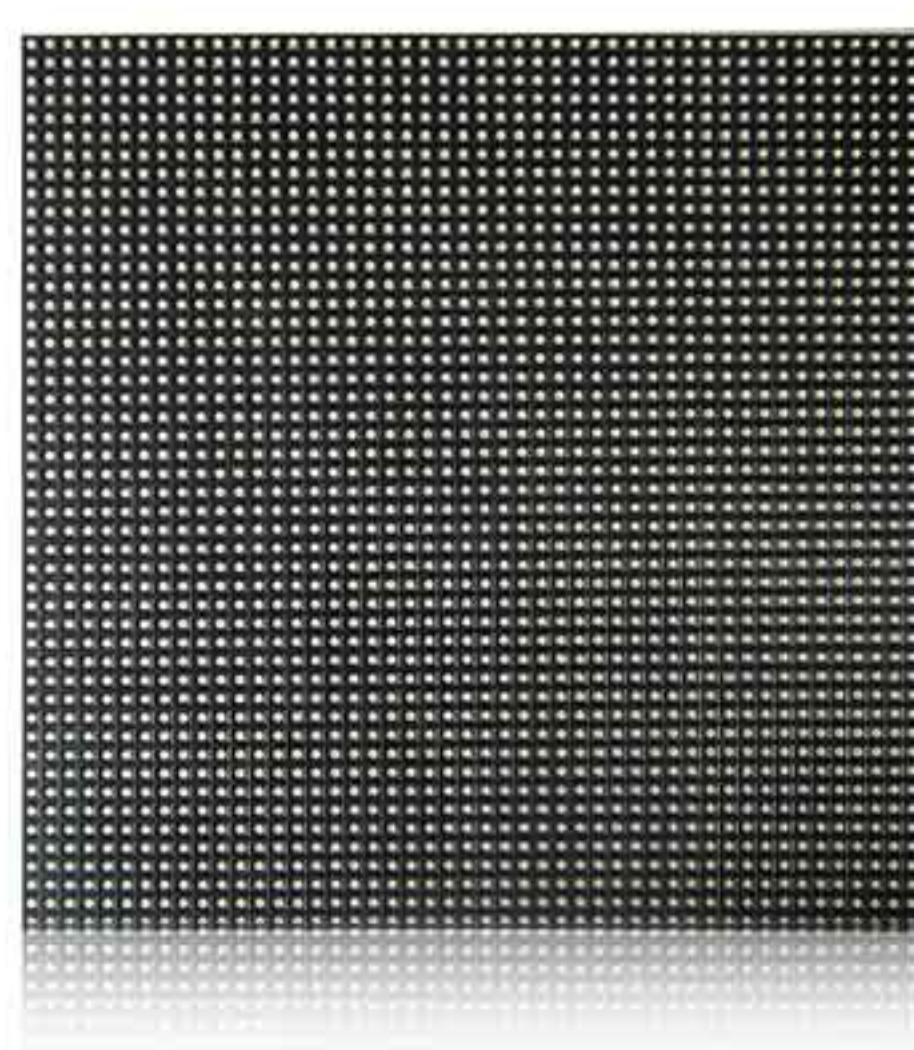



### 360° Transparent Foldable LED Screen

Application Environment	Outdoor		
Model	Smart T Plus (Rental/Fix installation/Led floor)		
Pixel Pitch (mm)	7.8	10.4	15.6
IP Rating	IP65(Double-sided glue filling, actual IP68)		
Transparent rate	16.37%	11.95%	14.25%
LED Type	SMD 1921	SMD 1921	SMD 2727
Pixel Density (pixel/m <sup>2</sup> )	16384	9216	4096
Driving Mode	1/8	1/4	1/2
Gray Scale (bit)	16	16	16
Max Brightness(cooper wire led) (nits)	5000	/	/
Max Brightness(golden wire led) (nits)	6000	6000	5000
Max Power Consumption (cooper wire led) (w/m <sup>2</sup> )	400	/	/
Max Refresh Rate (Hz)	7680	8000	8000
Module Resolution (pixels)	32 * 48	24 * 32	16 * 24
Module Size (mm)	250 * 375	250 * 333.33	250 * 375
Module thickness (mm)	15	15	15
Weight (kg/m <sup>2</sup> )	12	12	12
Folding Angle	360°	360°	360°
Viewing Angle (H/V)	120° / 120°	120° / 120°	120° / 120°
Output Voltage (V)	DC24V/48V	DC24V/48V	DC24V/48V
Input Voltage (V)	AC100 ~ AC240	AC100 ~ AC240	AC100 ~ AC240
Maximum load height of single control box (m)	20m (Multiple steel wire load-bearing)	25m (Multiple steel wire load-bearing)	30m (Multiple steel wire load-bearing)
Best Viewing Distance (m)	≥8	≥10	≥15
Brightness adjustment (digital) (levels)	256	256	256
Brightness adjustment (analog current) (levels)	64-256	64-256	64-256
Contrast	2500:1	2500:1	2500:1
Connection Type (Standard configuration) (Quick maintenance)	2+14pin Soldering 50pin Connector	2+14pin Soldering 50pin Connector	2+14pin Soldering 50pin Connector
Short Circuit Protection	Yes	Yes	Yes
Quick Maintenance	Mechanical and electrical connections available		
Controlling Mode	Synchronous/Asynchronous		
Installation Method	Hanging / mounting / fixing / Led floor		
Operation temperature (C°)	-40 ~ 65	-40 ~ 65	-40 ~ 65
Operation humidity (RH)	0% ~ 90%	0% ~ 90%	0% ~ 90%

Certificate

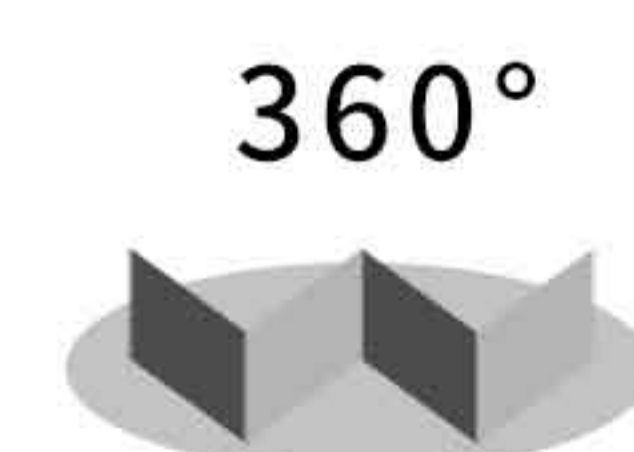
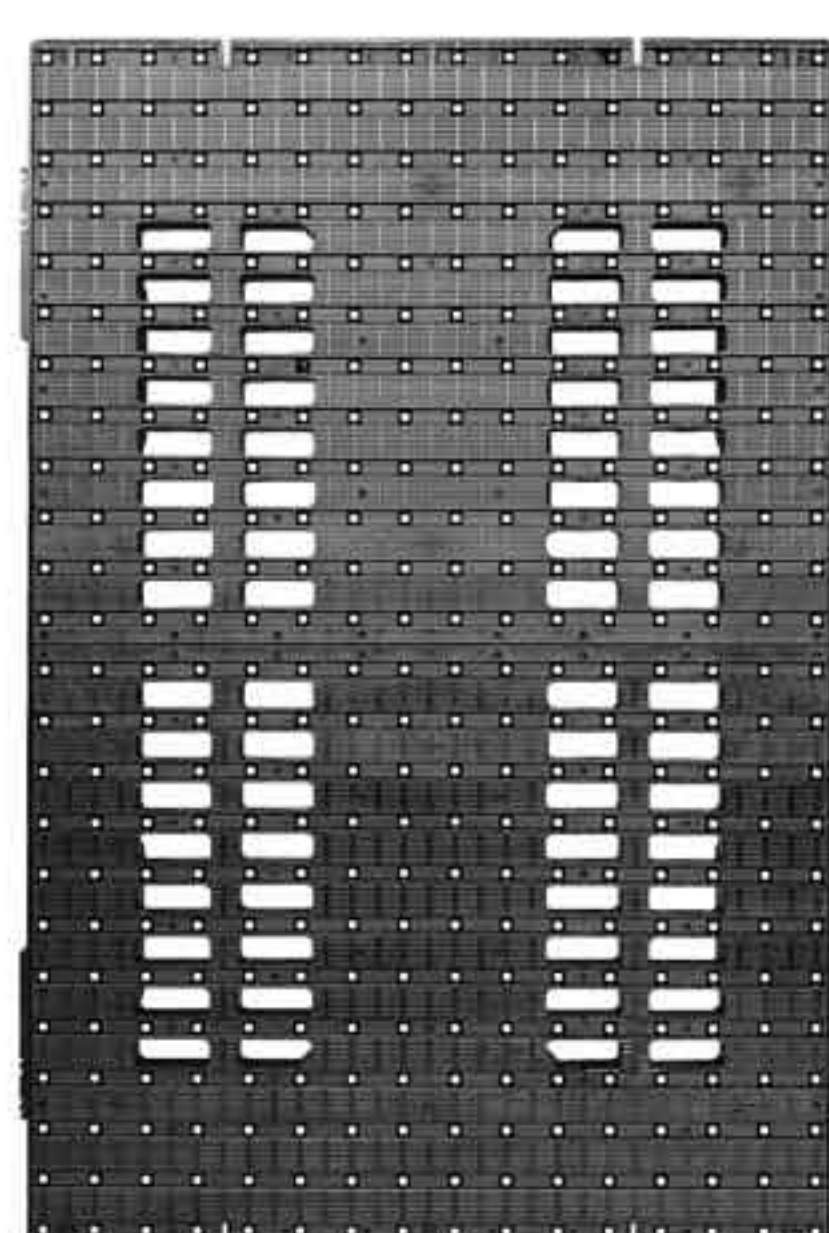



## 360° Transparent Foldable LED Screen

Application Environment	Outdoor			
Model	Smart T Plus (Rental/Fix installation/Led floor)			
Pixel Pitch (mm)	18.75-37.5		37.5	
LED Qty / Pixel	1	3	1	3
Module Resolution (pixels)	15*12	15*12	8*12	8*12
IP Rating	IP65(Double-sided glue filling, actual IP68)			
Transparent rate	56%			
LED Type	SMD 2727	SMD 2727	SMD 2727	SMD 2727
Pixel Density ( pixel/m <sup>2</sup> )	1333	4000	711	2133
Driving Mode	static scan	static scan	static scan	static scan
Gray Scale (bit)	65536	65536	65536	65536
Max Brightness(golden wire led) (nits)	2250	6750	1200	6000
Max Refresh Rate (Hz)	64000	64000	64000	64000
Module Size (mm)	300*450	300*450	300*450	300*450
Screen Thickness (mm)	23.5	23.5	23.5	23.5
Weight (kg/m <sup>2</sup> )	12	12	12	12
Folding Angle	360°	360°	360°	360°
Viewing Angle (H/V)	120° / 165°	120° / 165°	120° / 165°	120° / 165°
Max Power Consumption(golden wire led) (w/m <sup>2</sup> )	310	930	196	370
Output Voltage (V)	DC24	DC24	DC24	DC24
Input Voltage (V)	AC100 ~ AC240	AC100 ~ AC240	AC100 ~ AC240	AC100 ~ AC240
Max Height of a Panel (m)	76.5	76.5	76.5	76.5
Best Viewing Distance (m)	≥37.5	≥37.5	≥37.5	≥37.5
Brightness adjustment (digital) (levels)	256	256	256	256
Brightness adjustment (analog current) (levels) (option)	64-256	64-256	64-256	64-256
Contrast	1000:1	1000:1	1000:1	1000:1
Connection Type (standard) (spare)	2+14pin Soldering 50pin Connector	2+14pin Soldering 50pin Connector	2+14pin Soldering 50pin Connector	2+14pin Soldering 50pin Connector
Short Circuit Protection	Yes	Yes	Yes	Yes
Quick Maintenance	Mechanical and electrical connections available			
Controlling Mode	Synchronous/Asynchronous			
Installation Method	Hanging / mounting / fixing / Led floor			
Operation temperature (°C)	-40 ~ 65	-40 ~ 65	-40 ~ 65	-40 ~ 65
Operation humidity (RH)	0% ~ 90%	0% ~ 90%	0% ~ 90%	0% ~ 90%

Certificate

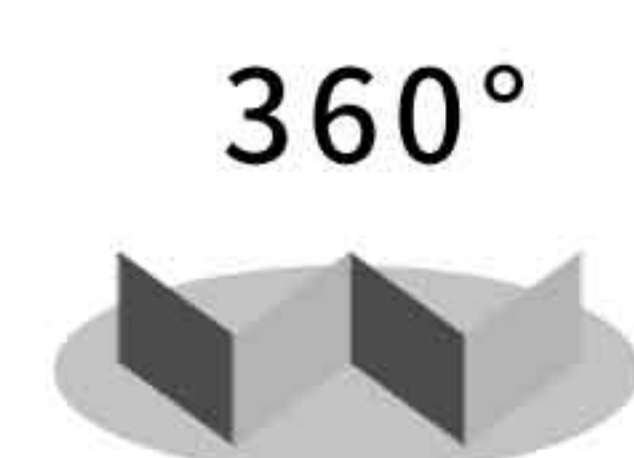
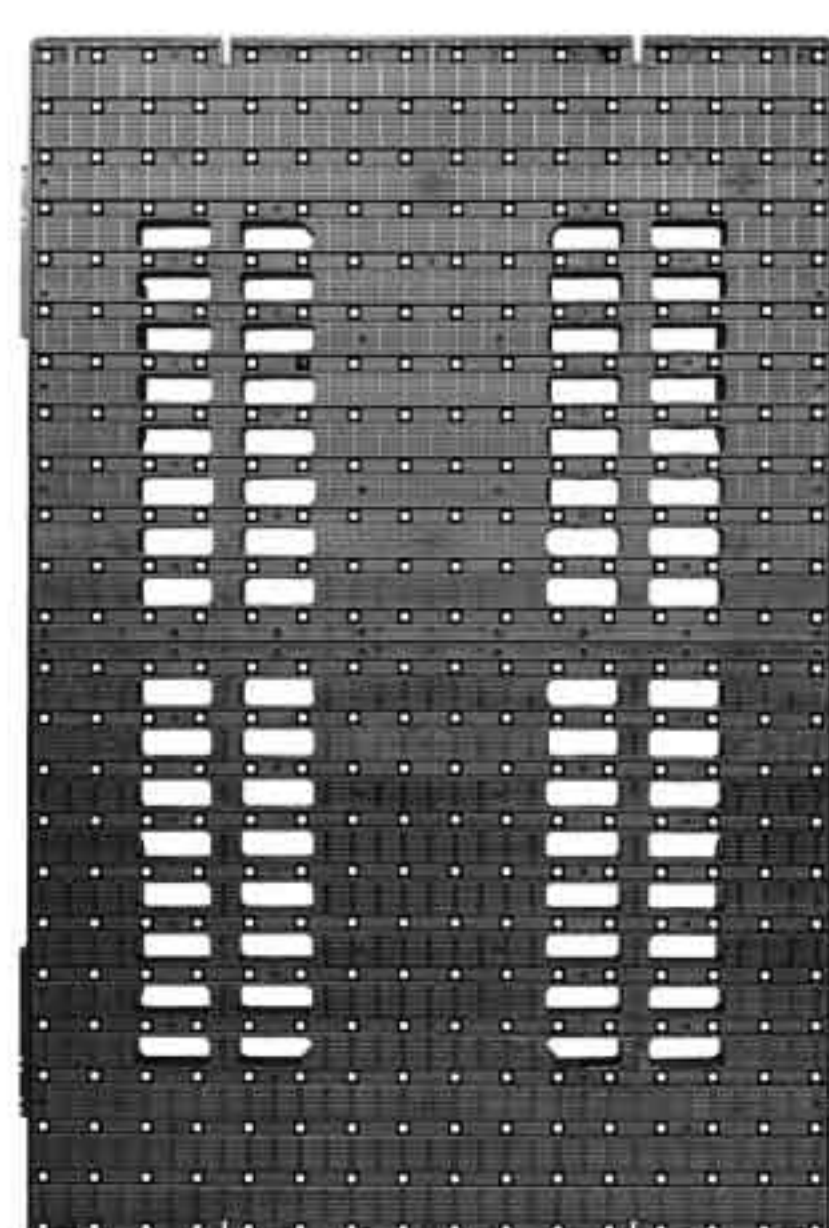



## 360° Transparent Foldable LED Screen

Application Environment	Outdoor			
Model	Smart T Plus (Rental/Fix installation/Led floor)			
Pixel Pitch (mm)	18.75-37.5		37.5	
LED Qty / Pixel	1	3	1	3
Module Resolution (pixels)	15*12	15*12	8*12	8*12
IP Rating	IP65(Double-sided glue filling, actual IP68)			
Transparent rate	56%			
LED Type	SMD 2727	SMD 2727	SMD 2727	SMD 2727
Pixel Density ( pixel/m <sup>2</sup> )	1333	4000	711	2133
Driving Mode	static scan	static scan	static scan	static scan
Gray Scale (bit)	65536	65536	65536	65536
Max Brightness(golden wire led) (nits)	2250	6750	1200	6000
Max Refresh Rate (Hz)	64000	64000	64000	64000
Module Size (mm)	300*450	300*450	300*450	300*450
Screen Thickness (mm)	23.5	23.5	23.5	23.5
Weight (kg/m <sup>2</sup> )	12	12	12	12
Folding Angle	360°	360°	360°	360°
Viewing Angle (H/V)	120° / 165°	120° / 165°	120° / 165°	120° / 165°
Max Power Consumption(golden wire led) (w/m <sup>2</sup> )	310	930	196	370
Output Voltage (V)	DC24	DC24	DC24	DC24
Input Voltage (V)	AC100 ~ AC240	AC100 ~ AC240	AC100 ~ AC240	AC100 ~ AC240
Max Height of a Panel (m)	76.5	76.5	76.5	76.5
Best Viewing Distance (m)	≥37.5	≥37.5	≥37.5	≥37.5
Brightness adjustment (digital) (levels)	256	256	256	256
Brightness adjustment (analog current) (levels) (option)	64-256	64-256	64-256	64-256
Contrast	1000:1	1000:1	1000:1	1000:1
Connection Type (standard) (spare)	2+14pin Soldering 50pin Connector	2+14pin Soldering 50pin Connector	2+14pin Soldering 50pin Connector	2+14pin Soldering 50pin Connector
Short Circuit Protection	Yes	Yes	Yes	Yes
Quick Maintenance	Mechanical and electrical connections available			
Controlling Mode	Synchronous/Asynchronous			
Installation Method	Hanging / mounting / fixing / Led floor			
Operation temperature (°C)	-40 ~ 65	-40 ~ 65	-40 ~ 65	-40 ~ 65
Operation humidity (RH)	0% ~ 90%	0% ~ 90%	0% ~ 90%	0% ~ 90%
Certificate				

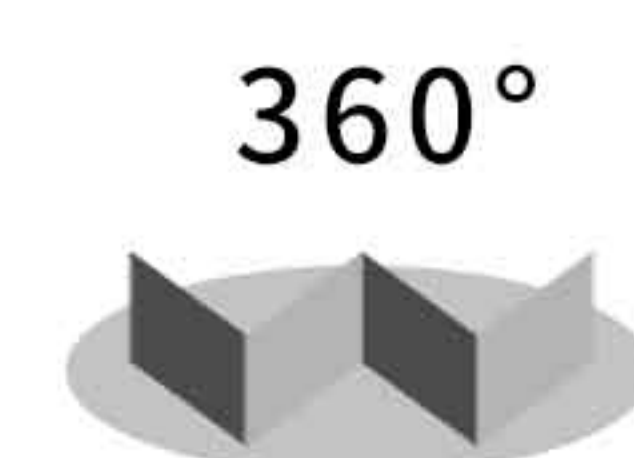
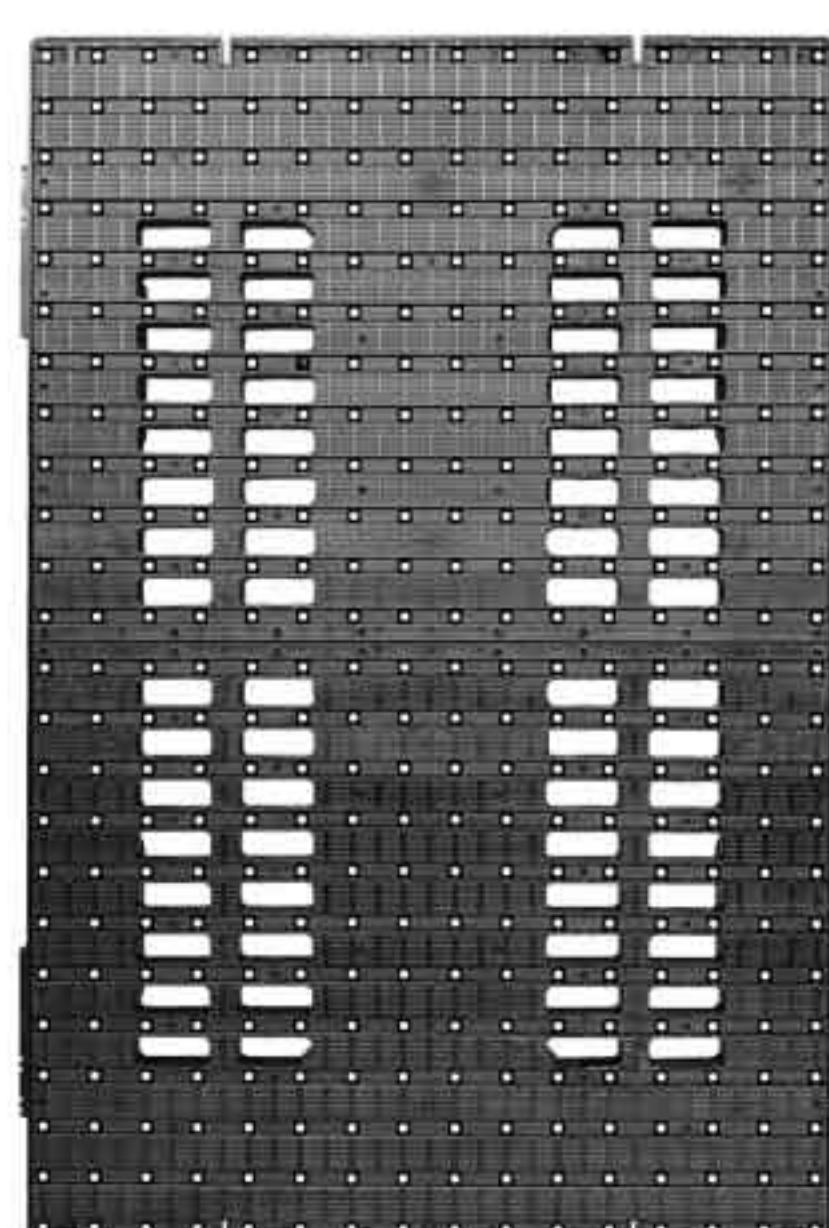







**维世**  
**ONUMEN**

## Onumen technology Co.,Ltd.

 +86-189-2384-8056 (Wechat, whatsapp)

 sales@onumen.com

 www.onumen.com

 4th Floor Building A3 Xiwan Zhiyuan Hangkong  
Road Bao'an District Shenzhen China

